

**11ILEVEN<sup>®</sup>**  
**INSTRUMENTS**

**PROMO**  
**2023**



**ENGLISH**  
**VERSION**



**WWW.ILEVENINSTRUMENTS.COM**

*Valid from 01.02.2023 - Suggested selling price to user*

*For corrections, changes and validity time, please refer to our website*

*For all non-promotional products please refer to our 2023 pricelist*

*Red codes: running out of stock - Codes marked with (E): economic alternative*

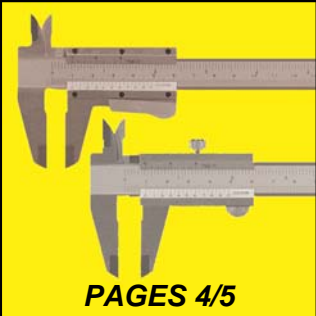

PAGES 4/5

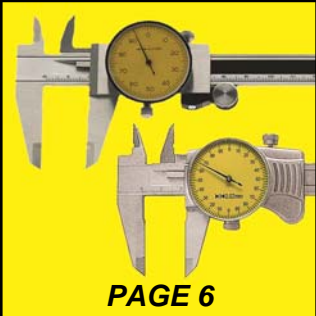

PAGE 6



PAGES 7/8



PAGES 9/10



PAGES 10/11



PAGE 12



PAGES 13/14

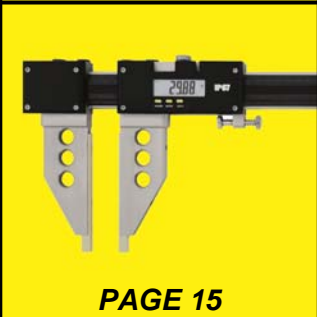

PAGE 15

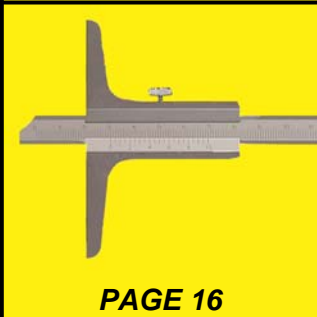

PAGE 16



PAGE 16

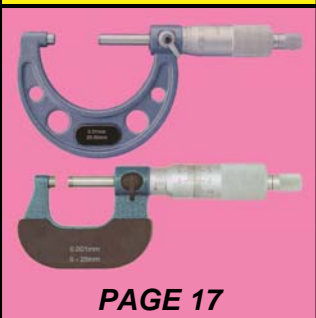

PAGE 17



PAGES 18/19



PAGES 20/21



PAGE 22



PAGE 23



PAGE 24



PAGE 25



PAGE 25



PAGE 26



PAGES 27/28



PAGE 29

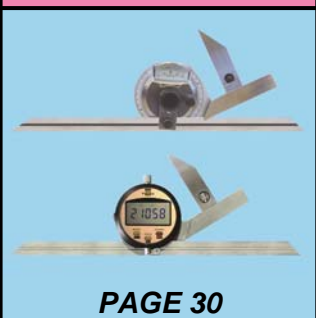

PAGE 30

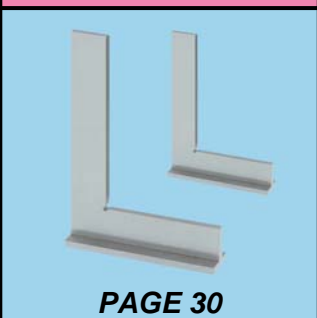

PAGE 30



PAGE 31



PAGES 32/33



PAGE 34



PAGE 35



PAGES 36/37



PAGES 39/40

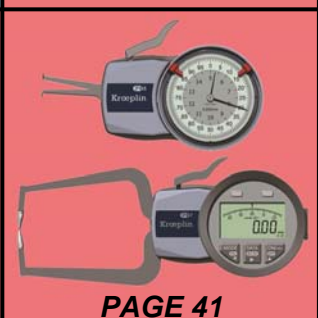

PAGE 41



PAGE 42



PAGE 43



PAGE 44



PAGE 45



PAGE 45



PAGE 46



PAGES 47/48



PAGE 49



PAGE 50



PAGES 51/52



PAGES 53/54

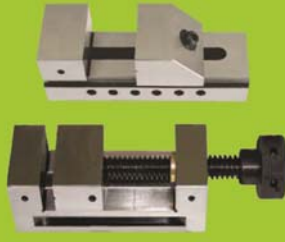

PAGE 55



PAGE 56



PAGE 57

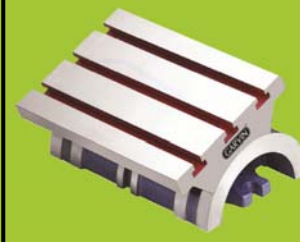

PAGE 58



PAGE 58



PAGE 59



PAGE 60



PAGE 60



PAGE 61



PAGE 62



PAGE 63

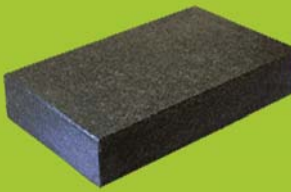

PAGE 64



PAGE 65



PAGES 66/67



PAGES 68/69



PAGES 70/71



PAGES 72/74



PAGE 75



PAGE 76



PAGE 77



PAGES 78/79



PAGE 80



PAGE 80



PAGE 81



PAGE 81

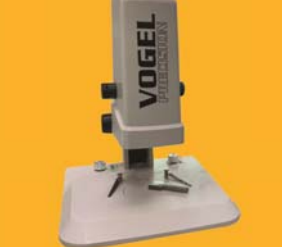

PAGE 82



PAGES 83



PAGE 84

Certifications and Calibration Reports



L'ENTE ITALIANO DI ACCREDITAMENTO

PAGES 85/89

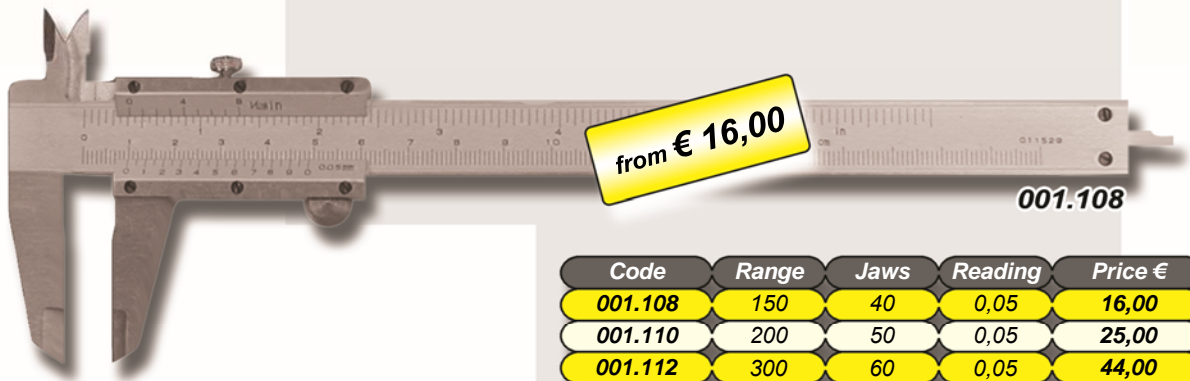

Code	Range	Jaws	Reading	Price €
001.108	150	40	0,05	16,00
001.110	200	50	0,05	25,00
001.112	300	60	0,05	44,00

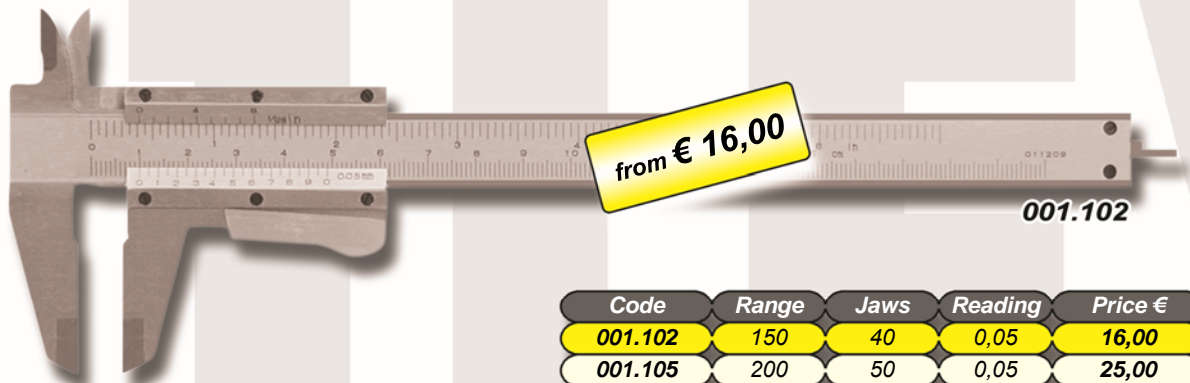

Code	Range	Jaws	Reading	Price €
001.102	150	40	0,05	16,00
001.105	200	50	0,05	25,00

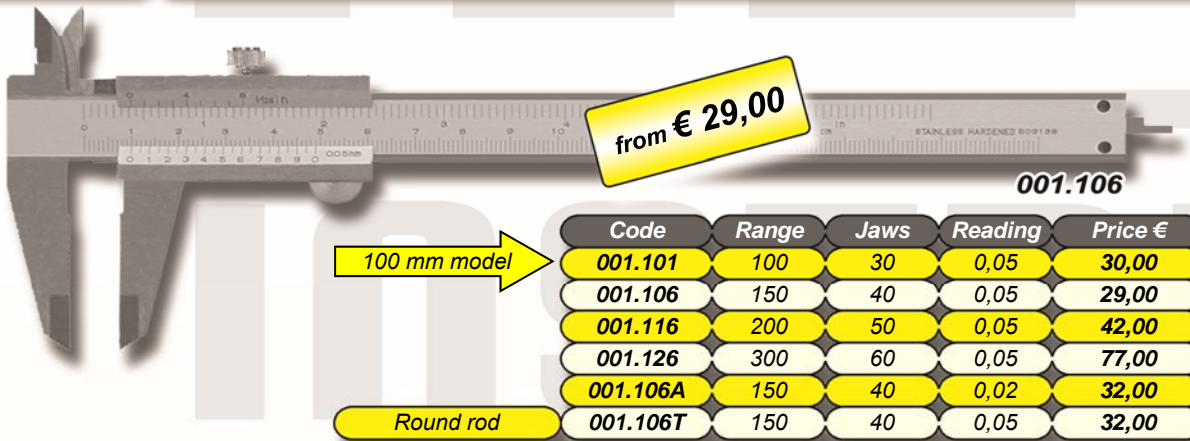

100 mm model →

Code	Range	Jaws	Reading	Price €
001.101	100	30	0,05	30,00
001.106	150	40	0,05	29,00
001.116	200	50	0,05	42,00
001.126	300	60	0,05	77,00
001.106A	150	40	0,02	32,00
001.106T	150	40	0,05	32,00

Round rod

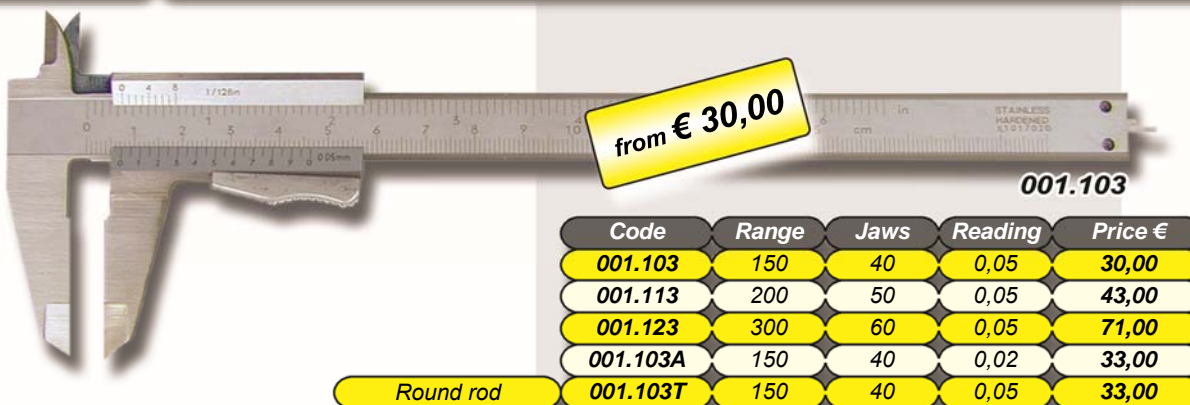

Code	Range	Jaws	Reading	Price €
001.103	150	40	0,05	30,00
001.113	200	50	0,05	43,00
001.123	300	60	0,05	71,00
001.103A	150	40	0,02	33,00
001.103T	150	40	0,05	33,00

Round rod

Monoblock calipers Top 1/20° and 1/50° - Top locking screw - Rectangular rod

Catalogue 1/6

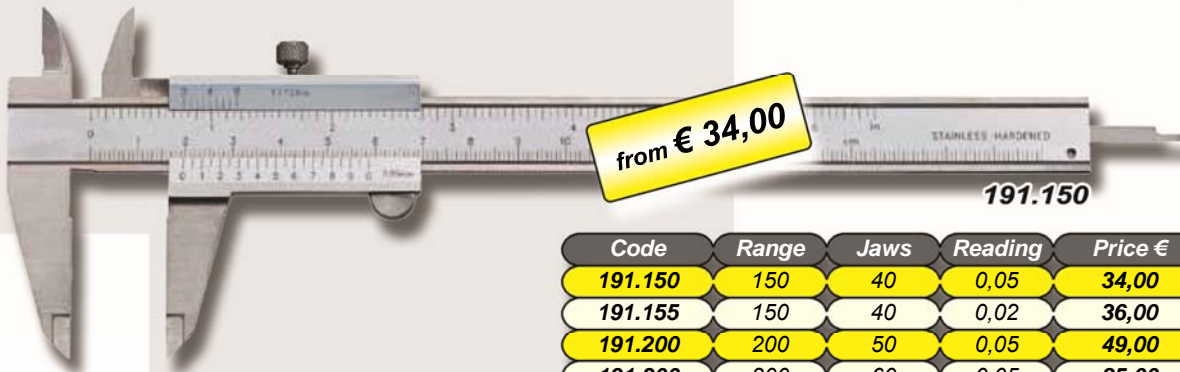

Code	Range	Jaws	Reading	Price €
191.150	150	40	0,05	34,00
191.155	150	40	0,02	36,00
191.200	200	50	0,05	49,00
191.300	300	60	0,05	85,00

Monoblock Top calipers 1/20° and 1/50° - Quick thumb lock - Rectangular rod

Catalogue 1/6

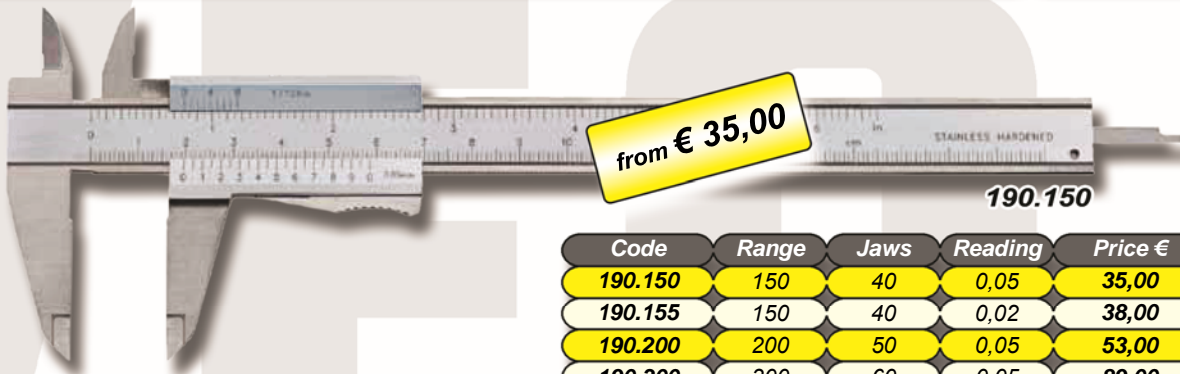

Code	Range	Jaws	Reading	Price €
190.150	150	40	0,05	35,00
190.155	150	40	0,02	38,00
190.200	200	50	0,05	53,00
190.300	300	60	0,05	89,00

Monoblock calipers 1/20° - With locking wheel

Catalogue 1/7

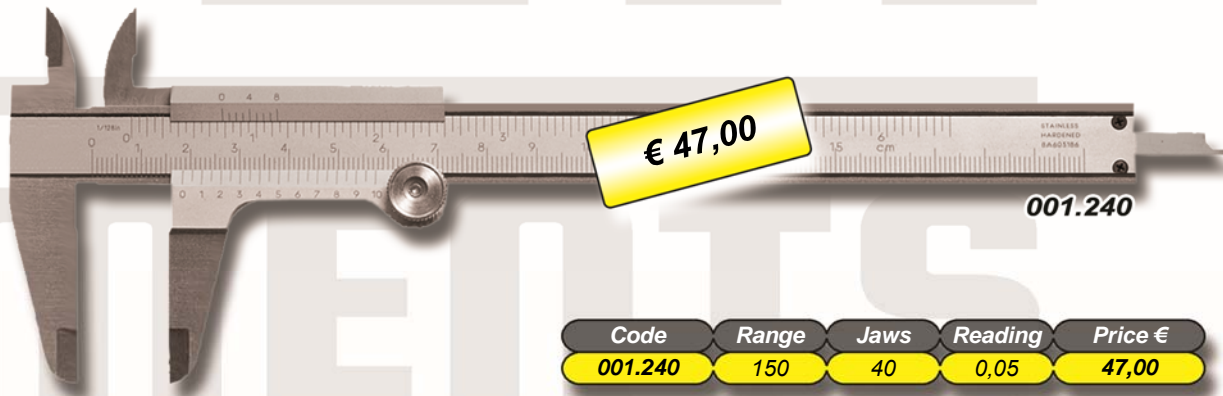

Code	Range	Jaws	Reading	Price €
001.240	150	40	0,05	47,00

PVC calipers holder - Quick release - Belt or adhesive connection

New



Code	Description	Price €
001.900	PVC calipers holder	26,00





Code	Range	Jaws	Reading	Price €
218.501	150	40	0,01	69,00
218.502	200	50	0,01	89,00
218.503	300	60	0,01	159,00

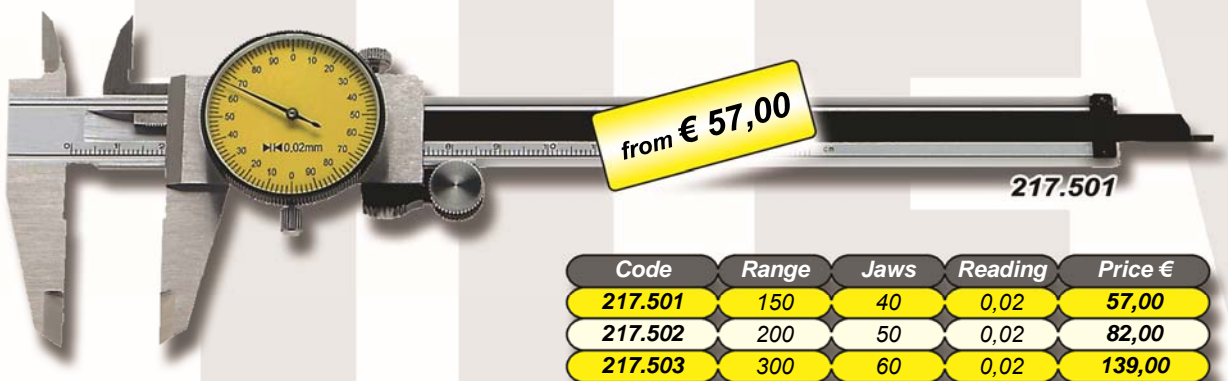

Code	Range	Jaws	Reading	Price €
217.501	150	40	0,02	57,00
217.502	200	50	0,02	82,00
217.503	300	60	0,02	139,00



Code	Range	Jaws	Reading	Price €
213.504G	200	50	0,01	65,00



Code	Range	Jaws	Reading	Price €
213.501G	150	40	0,02	42,00
213.502G	200	50	0,02	59,00
213.503G	300	60	0,02	92,00

Auto-on digital calipers - Last measurement memory - ABS - Wheel

Catalogue 1/13



Code	Range	Jaws	Reading	Price €
009.141	150	40	0,01	29,00
009.142	200	50	0,01	47,00
009.143	300	60	0,01	104,00

Digital calipers for left handers - Locking screw - Rectangular shaft - Wheel

Catalogue 1/18



Code	Range	Jaws	Reading	Price €
009.158	150	40	0,01	79,00

Digital calipers - Black rod - On/off - mm/inch - Zero - With wheel

Catalogue 1/14



Code	Range	Jaws	Reading	Price €
009.184	150	40	0,01	32,00

Calipers with quick thumb lock - Without wheel - Rectangular rod

Catalogue 1/18

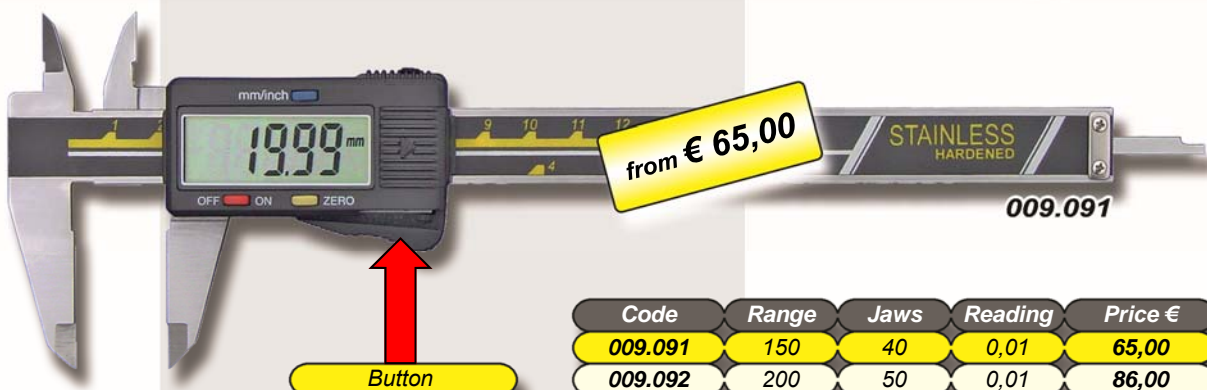

Code	Range	Jaws	Reading	Price €
009.091	150	40	0,01	65,00
009.092	200	50	0,01	86,00



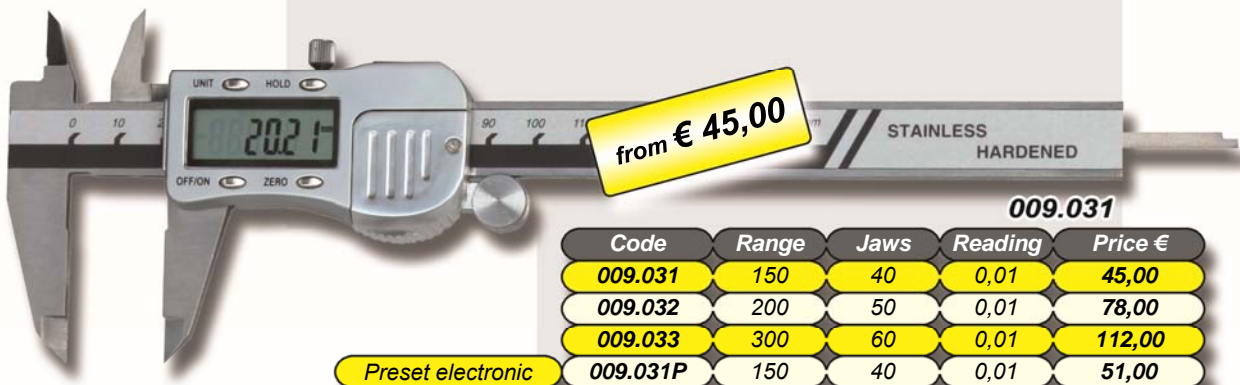

009.031

Code	Range	Jaws	Reading	Price €
009.031	150	40	0,01	45,00
009.032	200	50	0,01	78,00
009.033	300	60	0,01	112,00
009.031P	150	40	0,01	51,00

Preset electronic

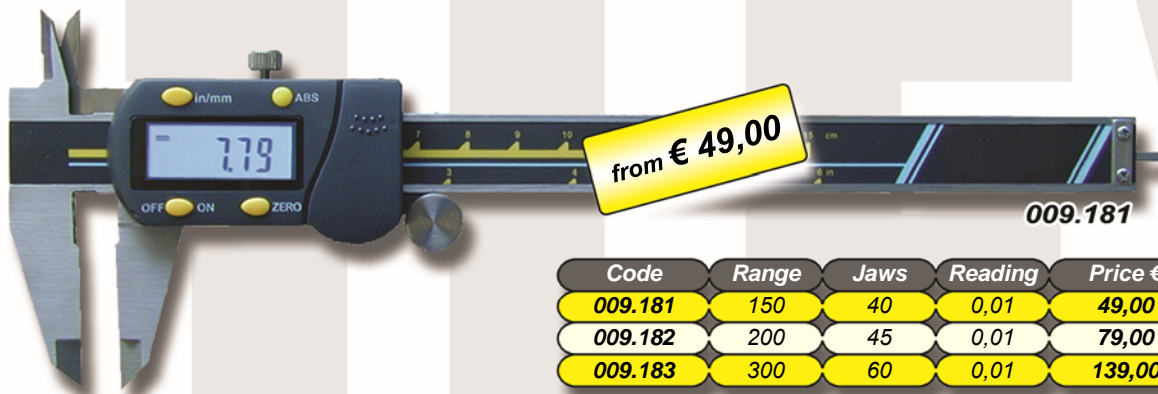

009.181

Code	Range	Jaws	Reading	Price €
009.181	150	40	0,01	49,00
009.182	200	45	0,01	79,00
009.183	300	60	0,01	139,00

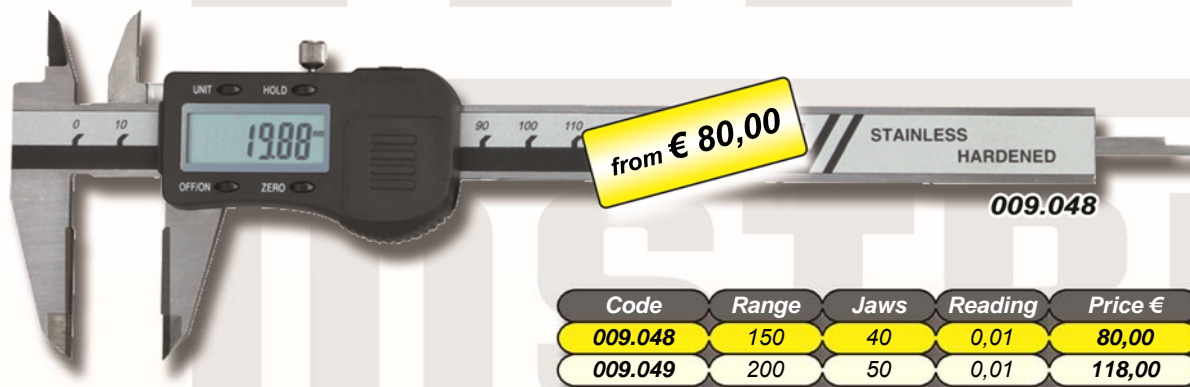

009.048

Code	Range	Jaws	Reading	Price €
009.048	150	40	0,01	80,00
009.049	200	50	0,01	118,00

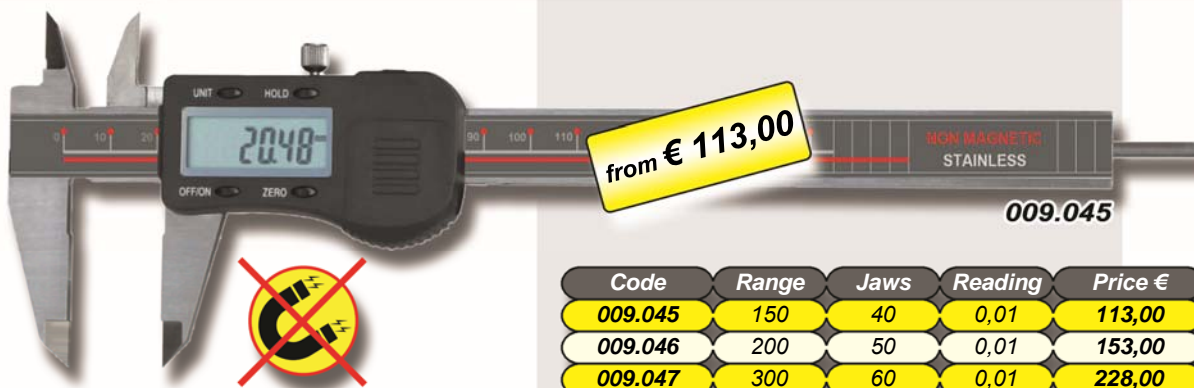

009.045

Code	Range	Jaws	Reading	Price €
009.045	150	40	0,01	113,00
009.046	200	50	0,01	153,00
009.047	300	60	0,01	228,00



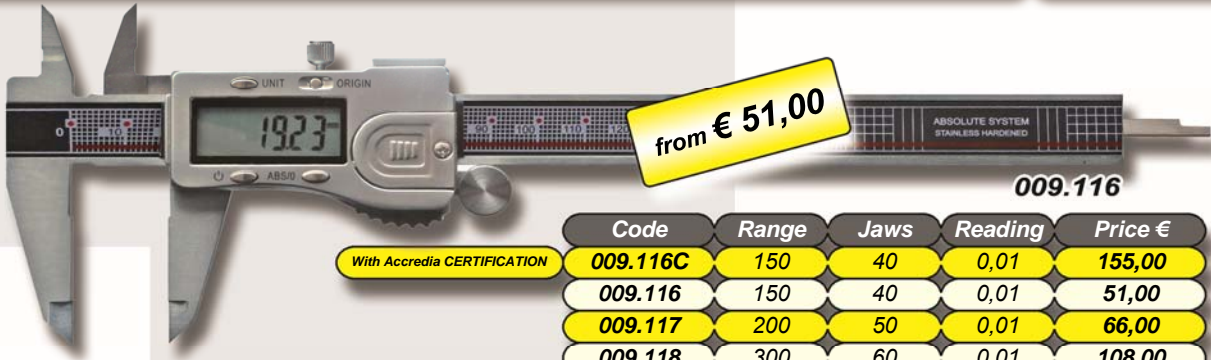

009.116

	Code	Range	Jaws	Reading	Price €
With Accredia CERTIFICATION	009.116C	150	40	0,01	155,00
	009.116	150	40	0,01	51,00
	009.117	200	50	0,01	66,00
	009.118	300	60	0,01	108,00
Round rod	009.119	150	40	0,01	55,00

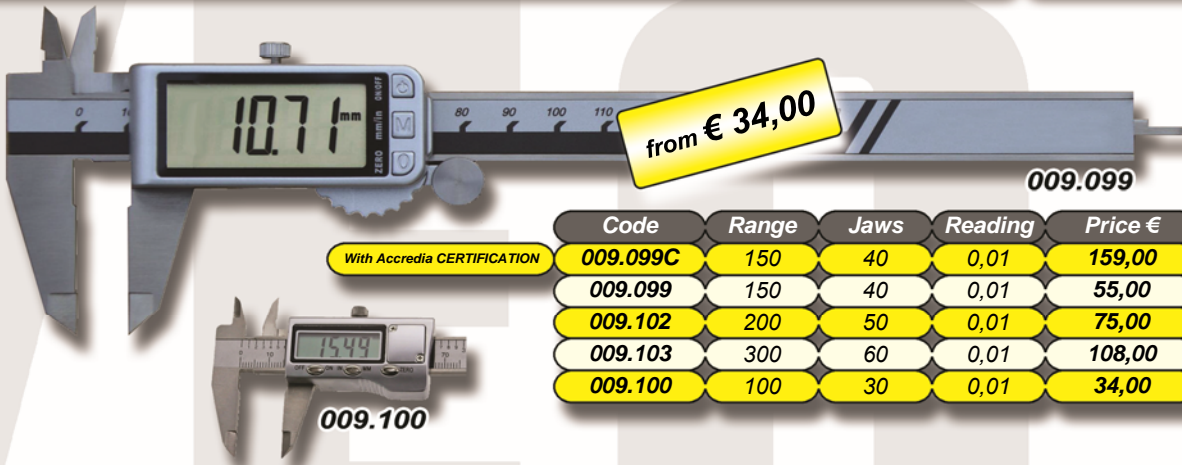

009.099

	Code	Range	Jaws	Reading	Price €
With Accredia CERTIFICATION	009.099C	150	40	0,01	159,00
	009.099	150	40	0,01	55,00
	009.102	200	50	0,01	75,00
	009.103	300	60	0,01	108,00
	009.100	100	30	0,01	34,00

Also available with Bluetooth

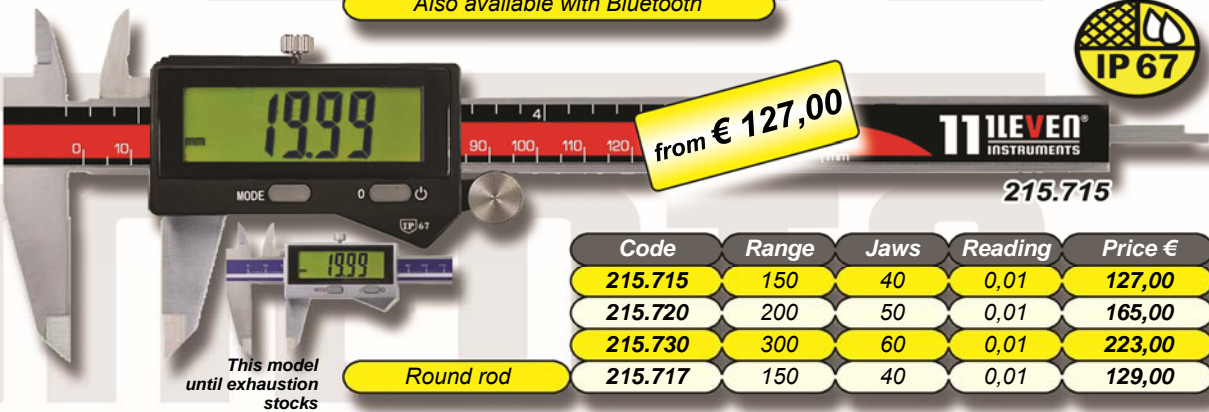

215.715

	Code	Range	Jaws	Reading	Price €
	215.715	150	40	0,01	127,00
	215.720	200	50	0,01	165,00
	215.730	300	60	0,01	223,00
Round rod	215.717	150	40	0,01	129,00

This model until exhaustion stocks

Sylvac electronic



220.806

	Code	Range	Jaws	Reading	Price €
	220.806	150	40	0,01	269,00

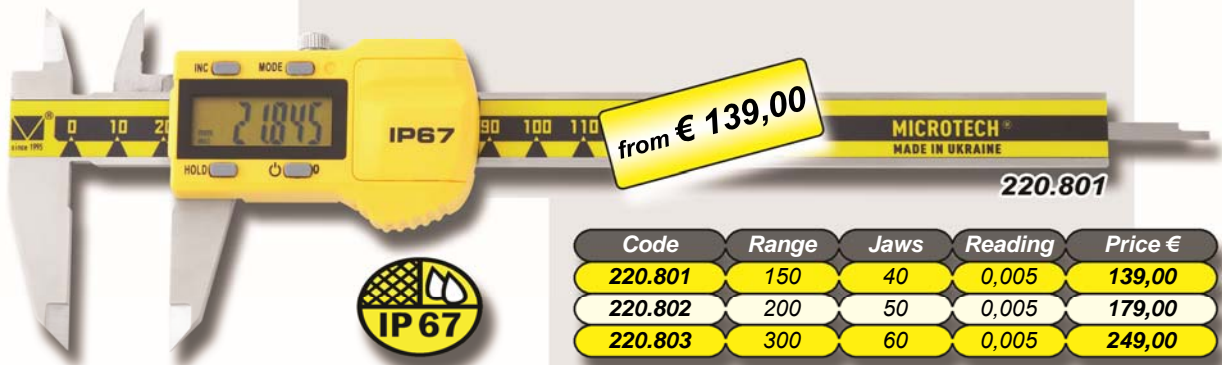

Code	Range	Jaws	Reading	Price €
220.801	150	40	0,005	139,00
220.802	200	50	0,005	179,00
220.803	300	60	0,005	249,00

Aluminium case (220.795P - PVC)

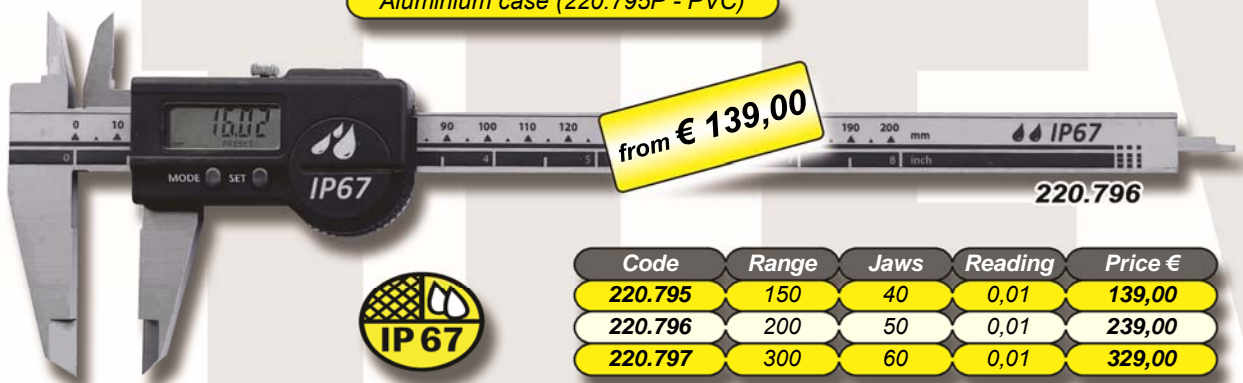

Code	Range	Jaws	Reading	Price €
220.795	150	40	0,01	139,00
220.796	200	50	0,01	239,00
220.797	300	60	0,01	329,00

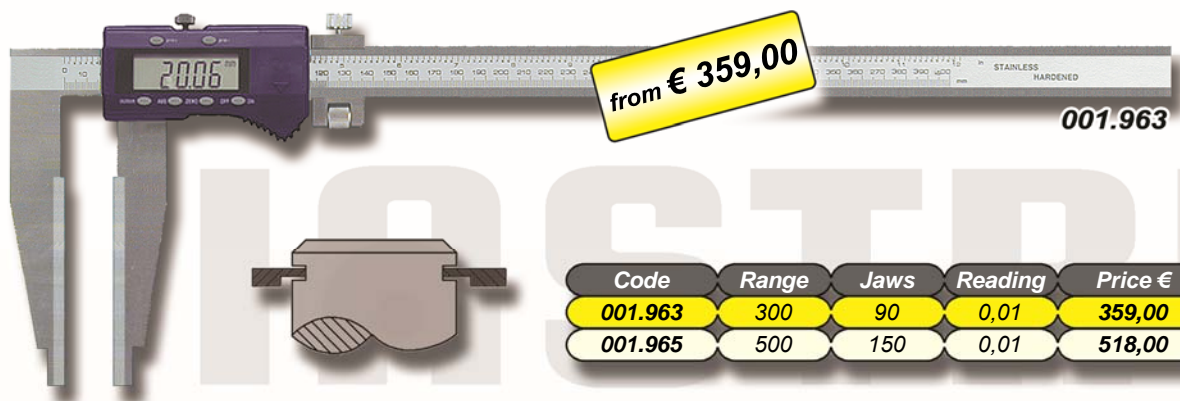

Code	Range	Jaws	Reading	Price €
001.963	300	90	0,01	359,00
001.965	500	150	0,01	518,00

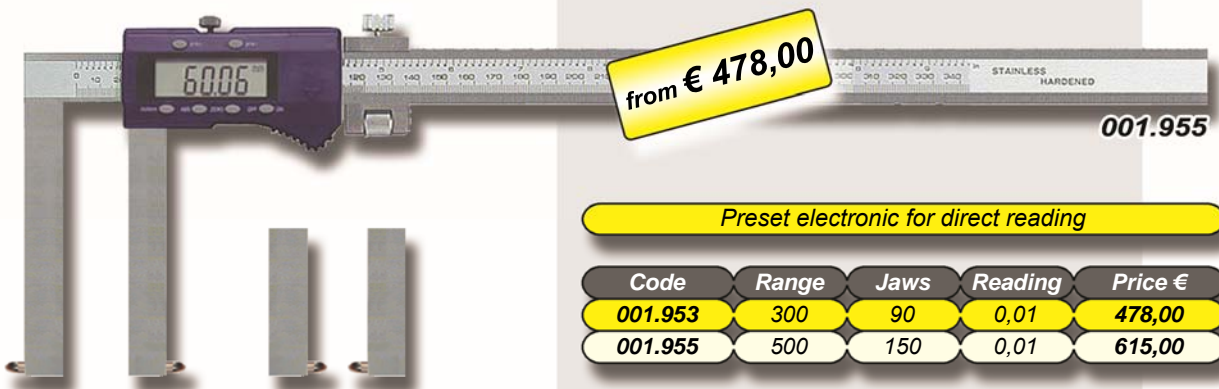

Preset electronic for direct reading

Code	Range	Jaws	Reading	Price €
001.953	300	90	0,01	478,00
001.955	500	150	0,01	615,00

Special digital calipers - Teeth for inside groove heights - Rod reduction for 24 mm

Catalogue 1/30



Code	Range	Feet	Reading	Price €
009.714	3:140	4 x L3	0,01	159,00

Reverse calipers for inside grooves - Fixed rectangular feet - Wheel on request

Catalogue 1/34

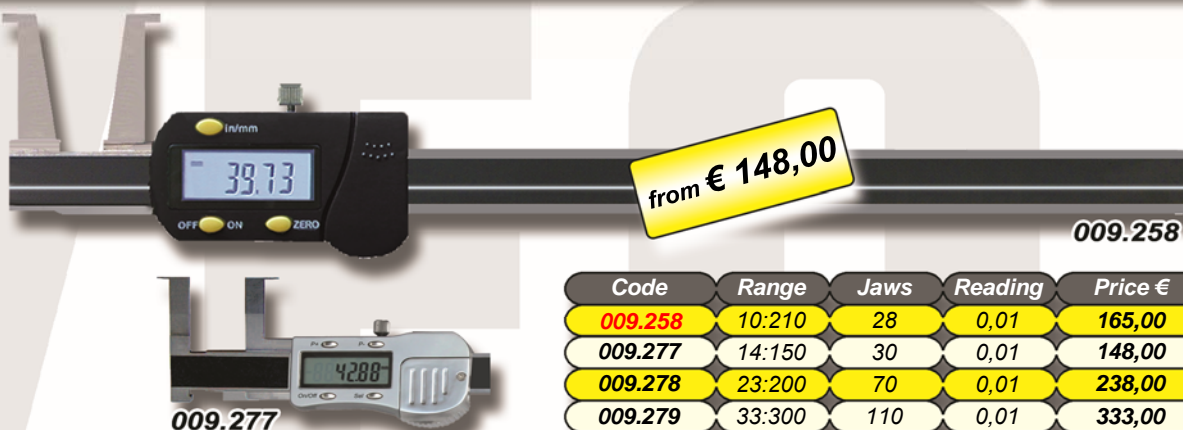

Code	Range	Jaws	Reading	Price €
009.258	10:210	28	0,01	165,00
009.277	14:150	30	0,01	148,00
009.278	23:200	70	0,01	238,00
009.279	33:300	110	0,01	333,00

Digital calipers for inside/outside grooves - M2.5 threaded jaws for contact points (dial gauges)

Catalogue 1/35

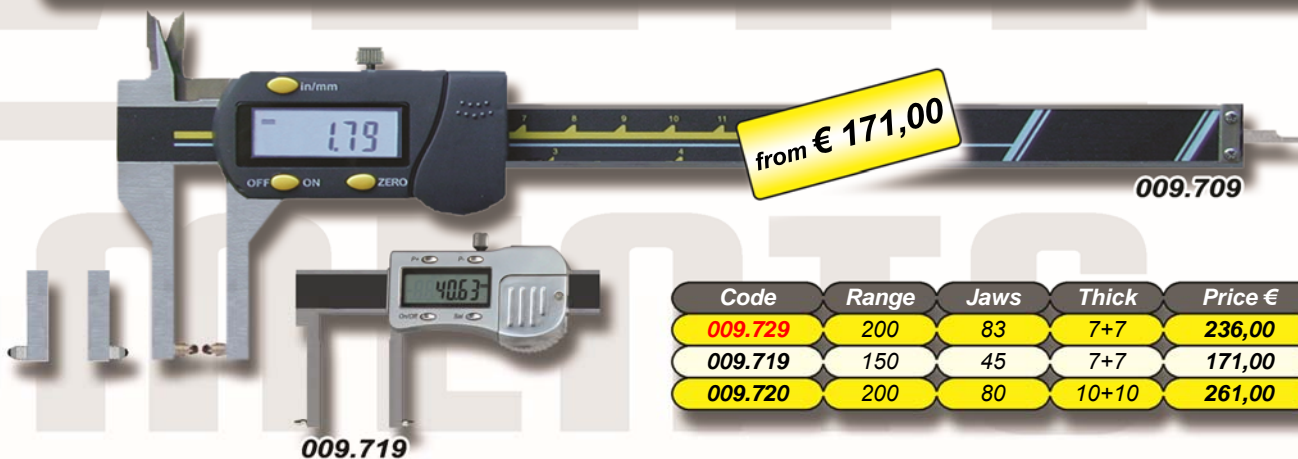

Code	Range	Jaws	Thick	Price €
009.729	200	83	7+7	236,00
009.719	150	45	7+7	171,00
009.720	200	80	10+10	261,00

Digital gauges with moveable jaws - On/off - Zero - Unit - Hold

Catalogue 1/26



Code	Range	Jaws	Reading	Price €
009.165	150	70/40	0,01	117,00
009.166	200	80/40	0,01	146,00



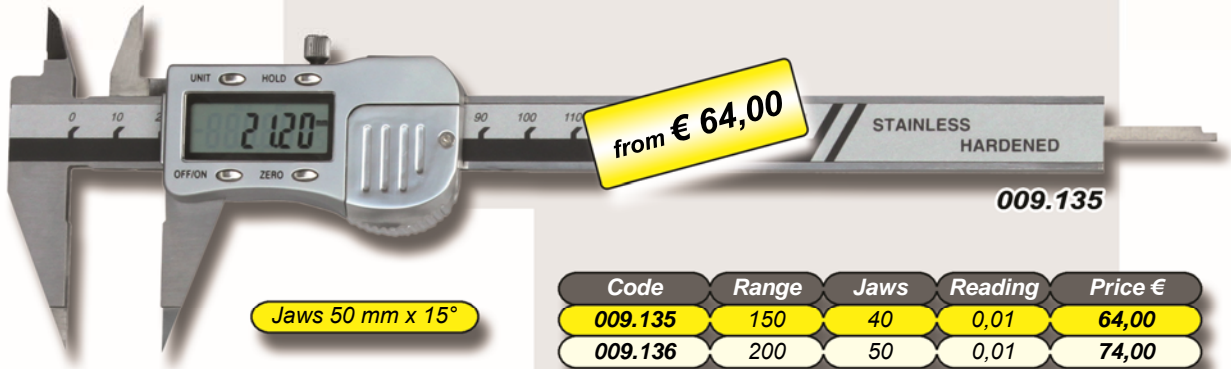

Jaws 50 mm x 15°

Code	Range	Jaws	Reading	Price €
009.135	150	40	0,01	64,00
009.136	200	50	0,01	74,00



Upper jaws h45mm x 7

Code	Range	Jaws	Reading	Prezzo €
009.290	200	50	0,01	113,00

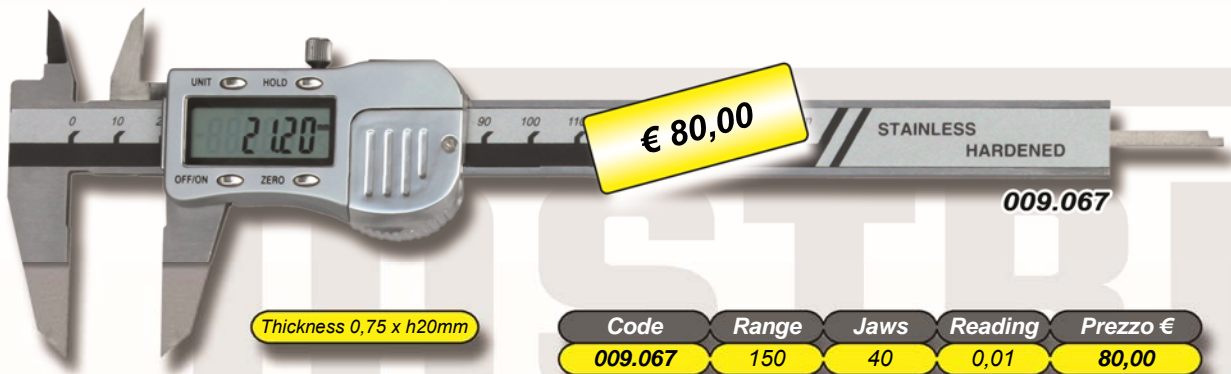

Thickness 0,75 x h20mm

Code	Range	Jaws	Reading	Prezzo €
009.067	150	40	0,01	80,00

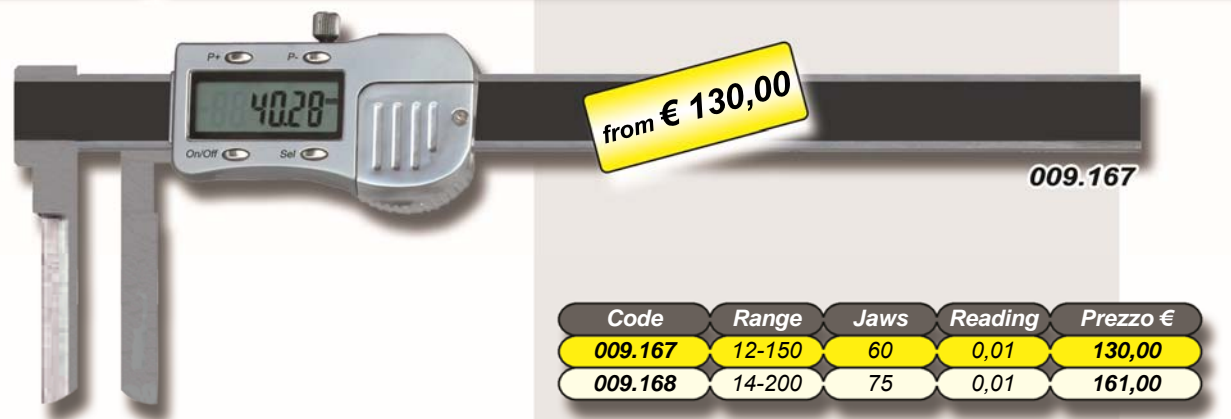

Code	Range	Jaws	Reading	Prezzo €
009.167	12-150	60	0,01	130,00
009.168	14-200	75	0,01	161,00

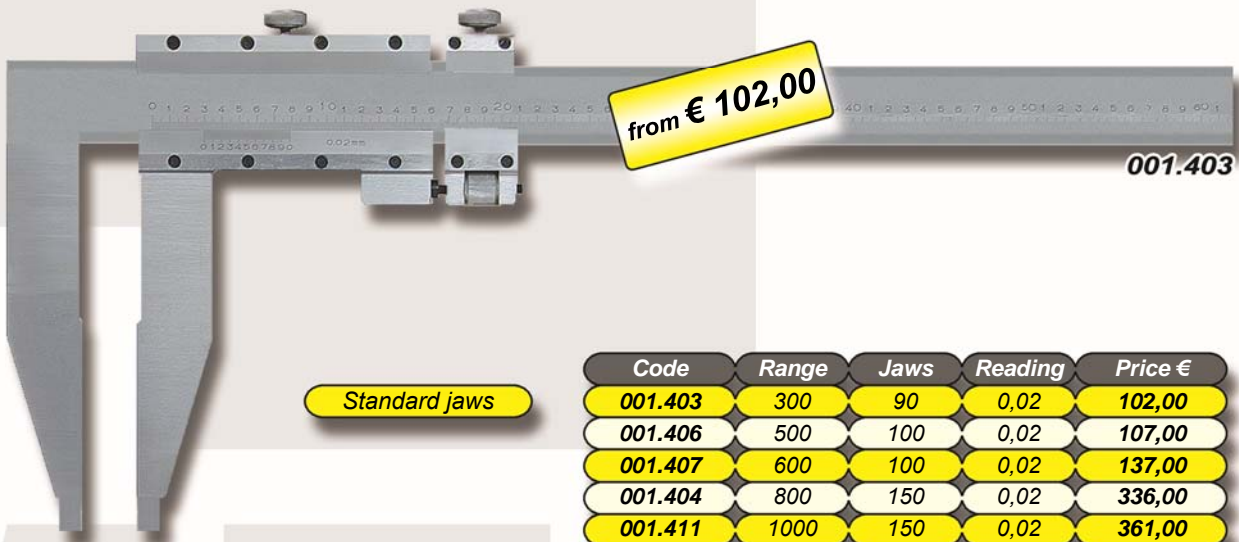

Standard jaws

Code	Range	Jaws	Reading	Price €
001.403	300	90	0,02	102,00
001.406	500	100	0,02	107,00
001.407	600	100	0,02	137,00
001.404	800	150	0,02	336,00
001.411	1000	150	0,02	361,00
001.412	1000	200	0,02	479,00
001.415	1500	200	0,02	807,00
001.420	2000	200	0,02	1237,00

Long jaws

001.408	500	150	0,02	155,00
001.409	600	150	0,02	168,00
001.405N	600	300	0,02	299,00
001.413	1000	300	0,02	510,00
001.410N	1000	500	0,02	999,00
001.421	2000	300	0,02	1199,00
001.425	2500	300	0,02	1845,00
001.430	3000	300	0,02	2298,00



Packaging in a wooden case cannot be claimed in case of breakage during transport

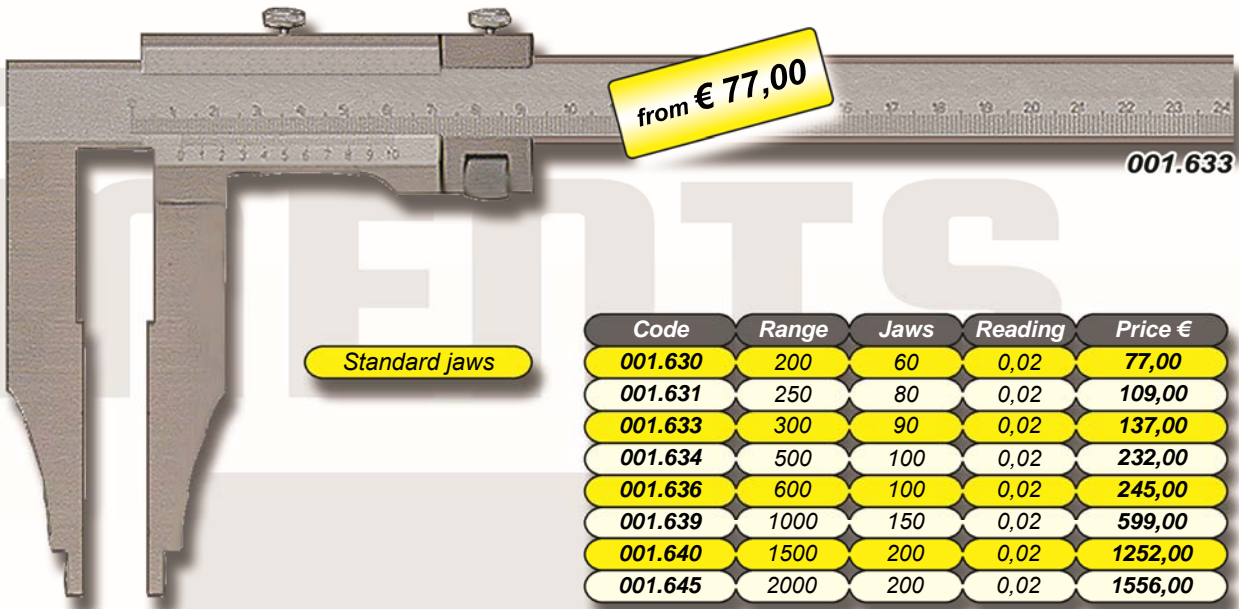

Standard jaws

Code	Range	Jaws	Reading	Price €
001.630	200	60	0,02	77,00
001.631	250	80	0,02	109,00
001.633	300	90	0,02	137,00
001.634	500	100	0,02	232,00
001.636	600	100	0,02	245,00
001.639	1000	150	0,02	599,00
001.640	1500	200	0,02	1252,00
001.645	2000	200	0,02	1556,00

Long jaws

001.762	300	150	0,02	250,00
001.635	500	150	0,02	310,00
001.769	500	250	0,02	523,00
001.637	600	150	0,02	341,00
001.774	600	300	0,02	699,00
001.775	1000	300	0,02	915,00
001.776	1000	500	0,02	1499,00
001.646	2000	300	0,02	2621,00
001.647	3000	300	0,02	3813,00



Packaging in a wooden case cannot be claimed in case of breakage during transport



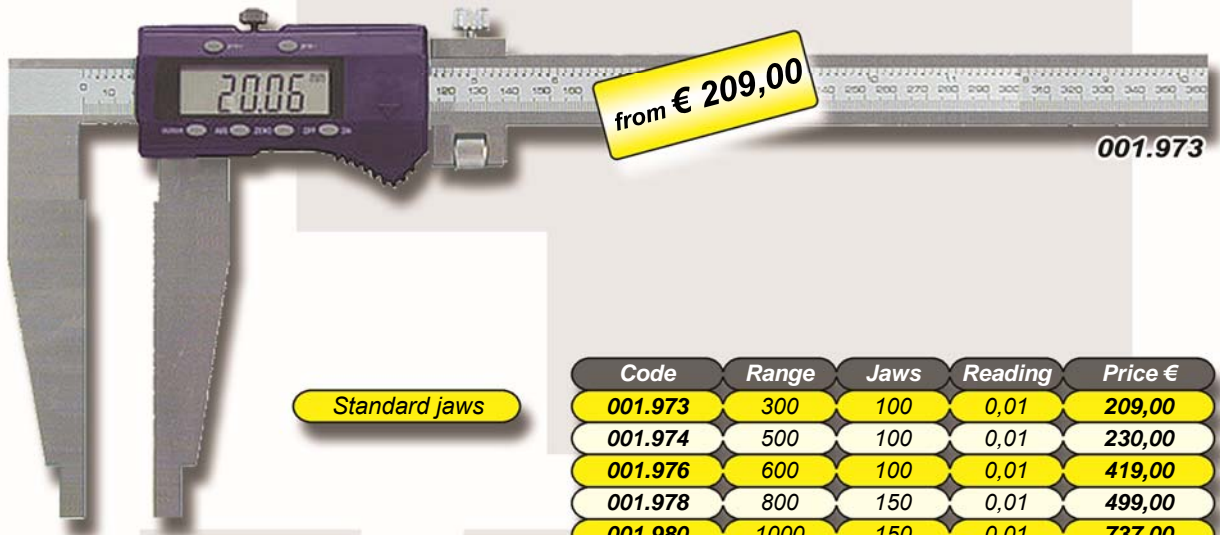

Standard jaws

Code	Range	Jaws	Reading	Price €
001.973	300	100	0,01	209,00
001.974	500	100	0,01	230,00
001.976	600	100	0,01	419,00
001.978	800	150	0,01	499,00
001.980	1000	150	0,01	737,00
009.479E	1000	150	0,01	609,00

Long jaws

001.972	300	150	0,01	259,00
001.975	500	150	0,01	279,00
001.975L	500	200	0,01	368,00
001.977	600	150	0,01	440,00
001.977L	600	200	0,01	490,00
001.979	600	300	0,01	648,00
001.980L	1000	300	0,01	1310,00
001.981	1500	200	0,01	1464,00
001.982	2000	200	0,01	2079,00
001.982L	2000	300	0,01	2124,00



Packaging in a wooden case cannot be claimed in case of breakage during transport



Standard jaws

Code	Range	Jaws	Reading	Price €
001.941	300	100	0,01	269,00
001.948	1000	150	0,01	838,00



Packaging in a wooden case cannot be claimed in case of breakage during transport

Keep away from magnets or strong magnetic fields!!!

Long jaws

Code	Range	Jaws	Reading	Price €
001.946	600	150	0,01	528,00
001.947	600	200	0,01	705,00
001.949	1000	200	0,01	1066,00



Code	Range	Jaws	Reading	Price €
009.005	500	100	0,01	311,00
009.006	800	150	0,01	567,00
009.007	1000	150	0,01	738,00

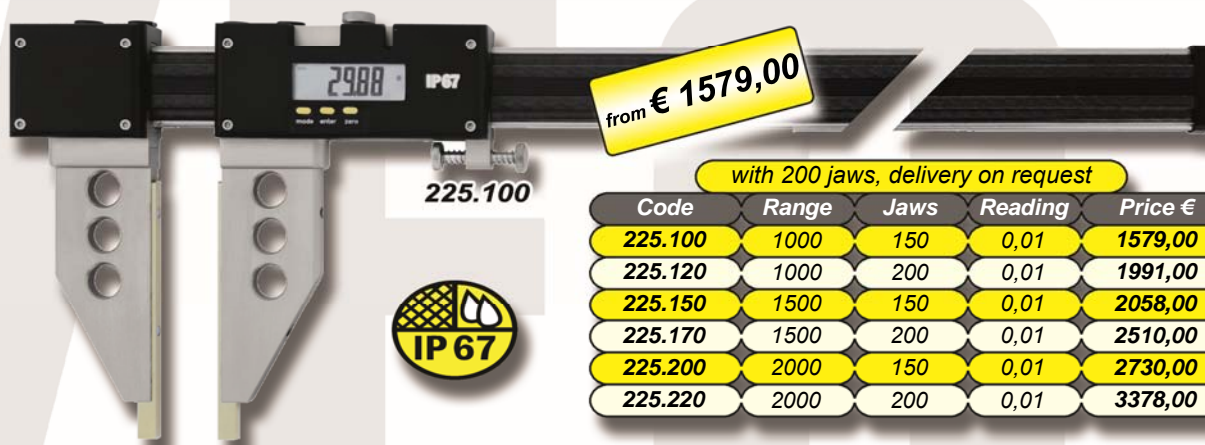

with 200 jaws, delivery on request

Code	Range	Jaws	Reading	Price €
225.100	1000	150	0,01	1579,00
225.120	1000	200	0,01	1991,00
225.150	1500	150	0,01	2058,00
225.170	1500	200	0,01	2510,00
225.200	2000	150	0,01	2730,00
225.220	2000	200	0,01	3378,00

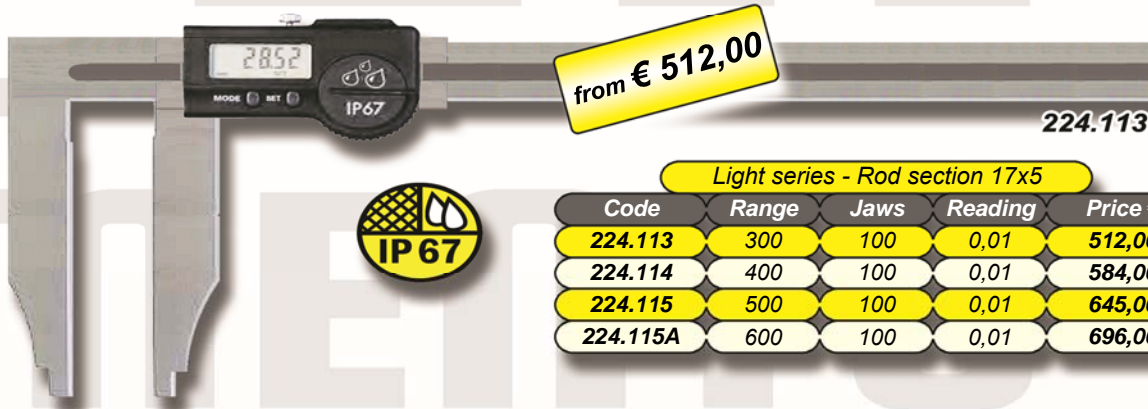

Light series - Rod section 17x5

Code	Range	Jaws	Reading	Price €
224.113	300	100	0,01	512,00
224.114	400	100	0,01	584,00
224.115	500	100	0,01	645,00
224.115A	600	100	0,01	696,00

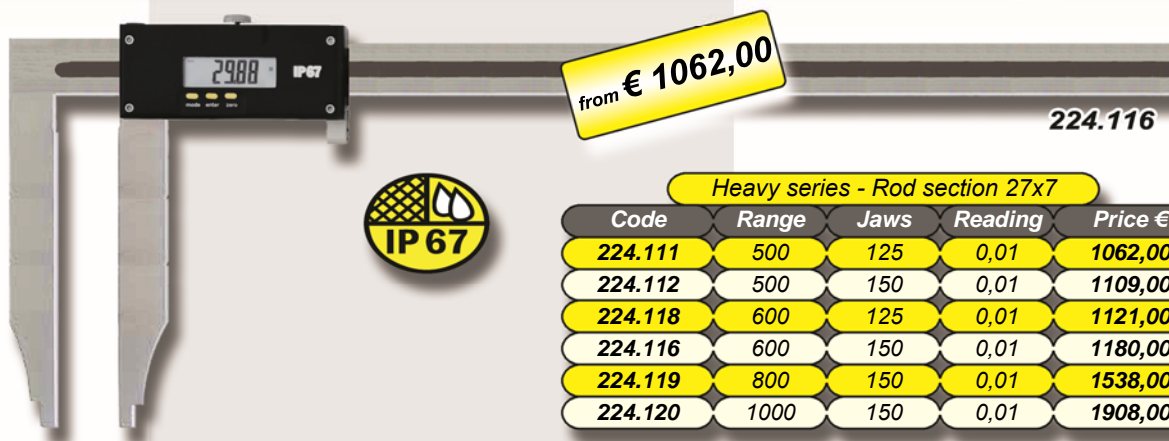

Heavy series - Rod section 27x7

Code	Range	Jaws	Reading	Price €
224.111	500	125	0,01	1062,00
224.112	500	150	0,01	1109,00
224.118	600	125	0,01	1121,00
224.116	600	150	0,01	1180,00
224.119	800	150	0,01	1538,00
224.120	1000	150	0,01	1908,00



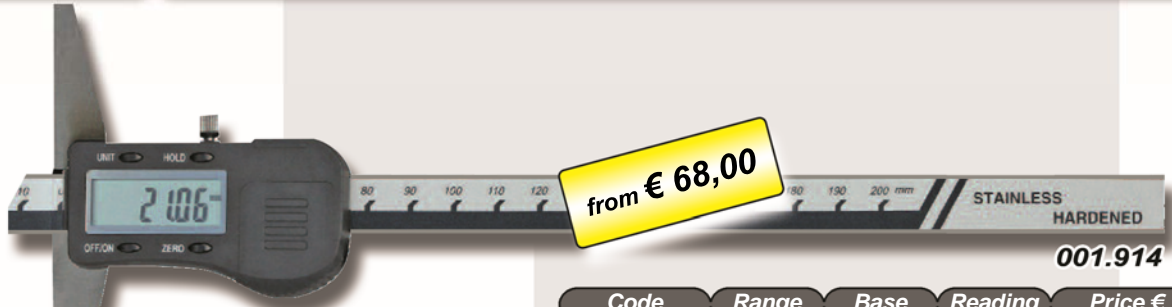

001.914

Code	Range	Base	Reading	Price €
001.912	150	100	0,01	68,00
001.914	200	100	0,01	79,00
001.913	300	100	0,01	107,00
001.917	200	150	0,01	90,00
001.916	300	150	0,01	130,00
001.915	500	150	0,01	195,00

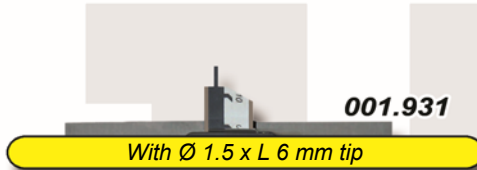

001.931

With  $\varnothing$  1.5 x L 6 mm tip

001.931	150	100	0,01	86,00
001.934	200	100	0,01	106,00
001.933	300	100	0,01	147,00
001.937	200	150	0,01	120,00
001.936	300	150	0,01	172,00



001.922

With hook for grooves  $\varnothing$  min. 21 mm

001.922	200	100	0,01	96,00
001.923	300	100	0,01	130,00
001.925	500	150	0,01	250,00



001.926

With double hook for grooves  $\varnothing$  min. 22 mm

001.926	200	100	0,01	123,00
001.927	300	100	0,01	132,00
001.928	500	100	0,01	247,00

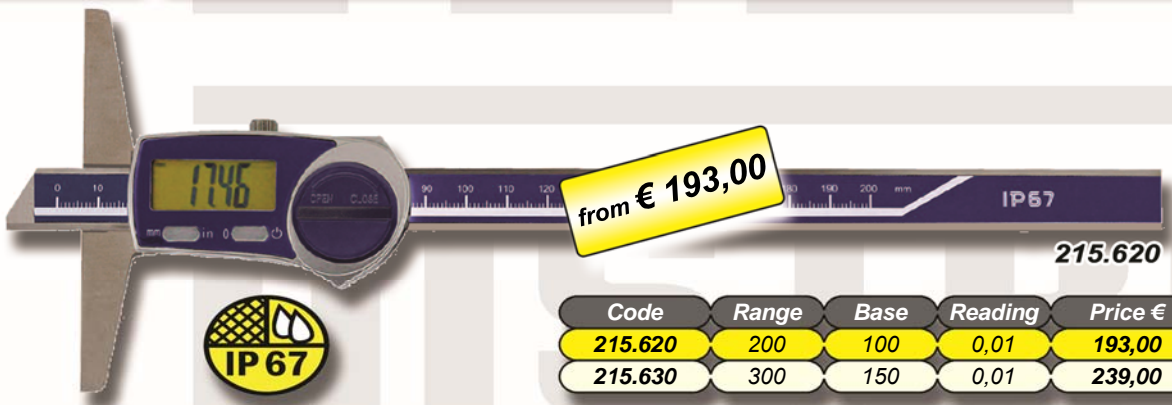

215.620

Code	Range	Base	Reading	Price €
215.620	200	100	0,01	193,00
215.630	300	150	0,01	239,00

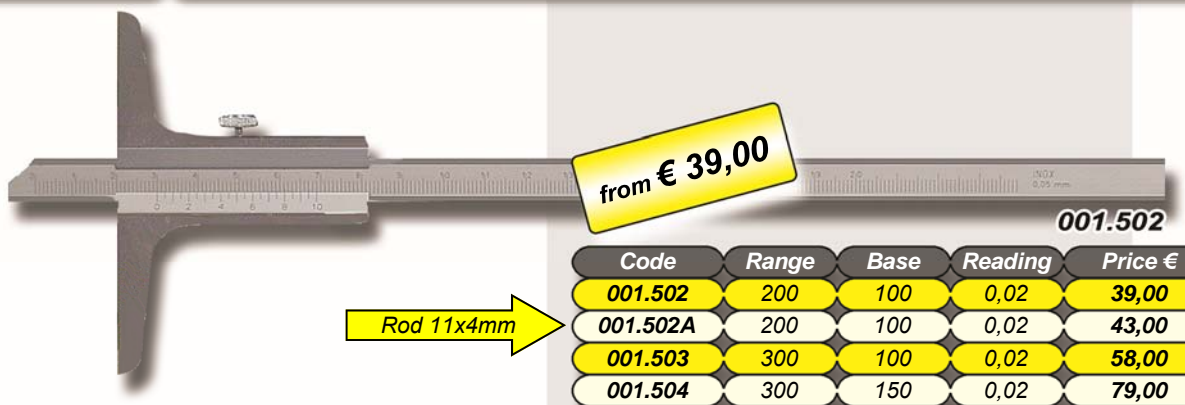

001.502

Code	Range	Base	Reading	Price €
001.502	200	100	0,02	39,00
001.502A	200	100	0,02	43,00
001.503	300	100	0,02	58,00
001.504	300	150	0,02	79,00

Rod 11x4mm



€ 31,00



002.891

from € 34,00



002.892

Code	Range	Setting	Arc	Price €
002.891	0:25	---	28	31,00
002.892	25:50	25	38	34,00
002.893	50:75	50	49	36,00
002.894	75:100	75	60	38,00

002.895	100:125	100	73	44,00
002.896	125:150	125	85	49,00
002.897	150:175	150	104	57,00
002.898	175:200	175	117	67,00

002.899	200:225	200	130	76,00
002.900	225:250	225	142	80,00
002.901	250:275	250	152	90,00
002.902	275:300	275	167	95,00

from € 115,00



002.903

Code	Range	Assortments	Price €
002.903	0:100	4 micrometers	115,00
002.905	100:200	4 micrometers	199,00
002.908	200:300	4 micrometers	347,00

from € 192,00



002.904

Code	Range	Assortments	Price €
002.904	0:150	6 micrometers	192,00
002.909	150:300	6 micrometers	394,00

€ 548,00

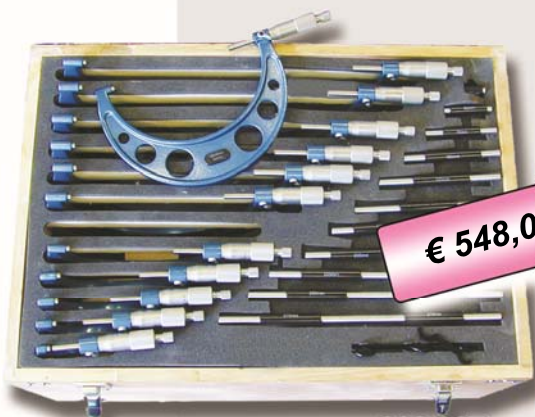

002.907

Code	Range	Assortments	Price €
002.907	0:300	12 micrometers	548,00





002.071

from € 27,00

Code	Range	Setting	Arc	Price €
002.071	0:25	---	24	27,00
002.072	25:50	25	32	31,00
002.073	50:75	50	45	38,00
002.074	75:100	75	57	42,00
002.075	100:125	100	70	48,00
002.076	125:150	125	82	57,00
002.077	150:175	150	95	68,00
002.080	175:200	175	107	74,00



002.078

from € 125,00

Code	Range	Assortments	Price €
002.078	0:100	4 micrometers	125,00
002.078A	100:200	4 micrometers	240,00
002.079	0:150	6 micrometers	213,00

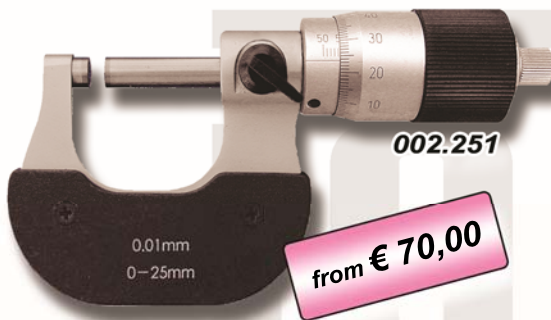

002.251

from € 70,00

Code	Range	Setting	Arc	Price €
002.251	0:25	---	24	70,00
002.252	25:50	25	32	76,00
002.253	50:75	50	45	81,00
002.254	75:100	75	57	100,00
002.255	100:125	100	70	114,00
002.256	125:150	125	82	126,00
002.257	150:175	150	95	144,00
002.258	175:200	175	107	159,00



002.501

from € 69,00

Reading 0,001mm

Code	Range	Setting	Arc	Price €
002.501	0:25	---	24	69,00
002.502	25:50	25	32	75,00
002.503	50:75	50	45	81,00
002.504	75:100	75	57	93,00



002.051

Code	Range	Setting	Arc	Price €
002.051	0:25	---	24	57,00
002.052	25:50	25	32	69,00
002.053	50:75	50	45	77,00
002.054	75:100	75	57	83,00

Hartig micrometers - Drum Ø 21 mm - Reading 0.01 - 0.5 mm pitch



808.501



Code	Range	Setting	Arc	Price €
808.501	0:25	---	24	251,00
808.502	25:50	25	34	333,00
808.503	50:75	50	46	360,00
808.504	75:100	75	60	387,00

Hartig micrometers - Drum Ø 25 mm - Reading 0.01 - 1 mm pitch



809.502



Code	Range	Setting	Arc	Price €
809.501	0:25	---	24	255,00
809.502	25:50	25	32	337,00
809.503	50:75	50	45	364,00
809.504	75:100	75	60	392,00

Hartig micrometers - Drum Ø 25 mm - Reading 0.005



811.501



Code	Range	Setting	Arc	Price €
811.501	0:25	---	24	286,00
811.502	25:50	25	34	353,00
811.503	50:75	50	46	374,00
811.504	75:100	75	60	400,00

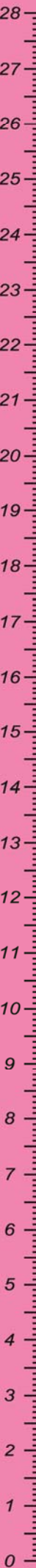



002.024D

Up to 1000 mm stroke 25 mm pitch 0.5 mm  
1 anvil 100 mm and 2 spacers 25 and 50



Over 1000 mm stroke 50 mm pitch 1 mm  
1 anvil 200 mm and 2 spacers 50 and 100



Code	Range	Travel	Drum	Pitch	Price €
002.021D	300:400	25	18	0,5	427,00
002.022D	400:500	25	18	0,5	475,00
002.023D	500:600	25	18	0,5	550,00
002.024D	600:700	25	18	0,5	634,00
002.025D	700:800	25	18	0,5	734,00
002.026D	800:900	25	18	0,5	868,00
002.027D	900:1000	25	18	0,5	944,00

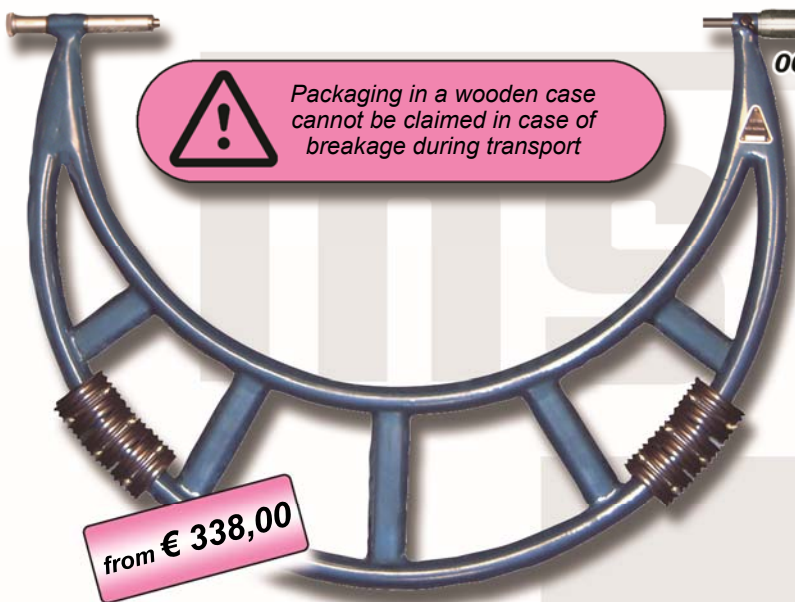

002.024

Up to 1000 mm stroke 25 mm pitch 0.5 mm  
1 anvil 100 mm and 2 spacers 25 and 50



Over 1000 mm stroke 50 mm pitch 1 mm  
1 anvil 200 mm and 2 spacers 50 and 100



Code	Range	Travel	Drum	Pitch	Price €	Code	Range	Travel	Drum	Pitch	Price €
002.021	300:400	25	18	0,5	338,00	002.028	1000:1200	50	30	1	1414,00
002.022	400:500	25	18	0,5	376,00	002.029	1200:1400	50	30	1	1621,00
002.023	500:600	25	18	0,5	453,00	002.030	1400:1600	50	30	1	1765,00
002.024	600:700	25	18	0,5	518,00	002.031	1600:1800	50	30	1	2013,00
002.025	700:800	25	18	0,5	623,00	002.032	1800:2000	50	30	1	2142,00
002.026	800:900	25	18	0,5	754,00						
002.027	900:1000	25	18	0,5	840,00						

Available up to 3000 mm with dial gauge - See page 21

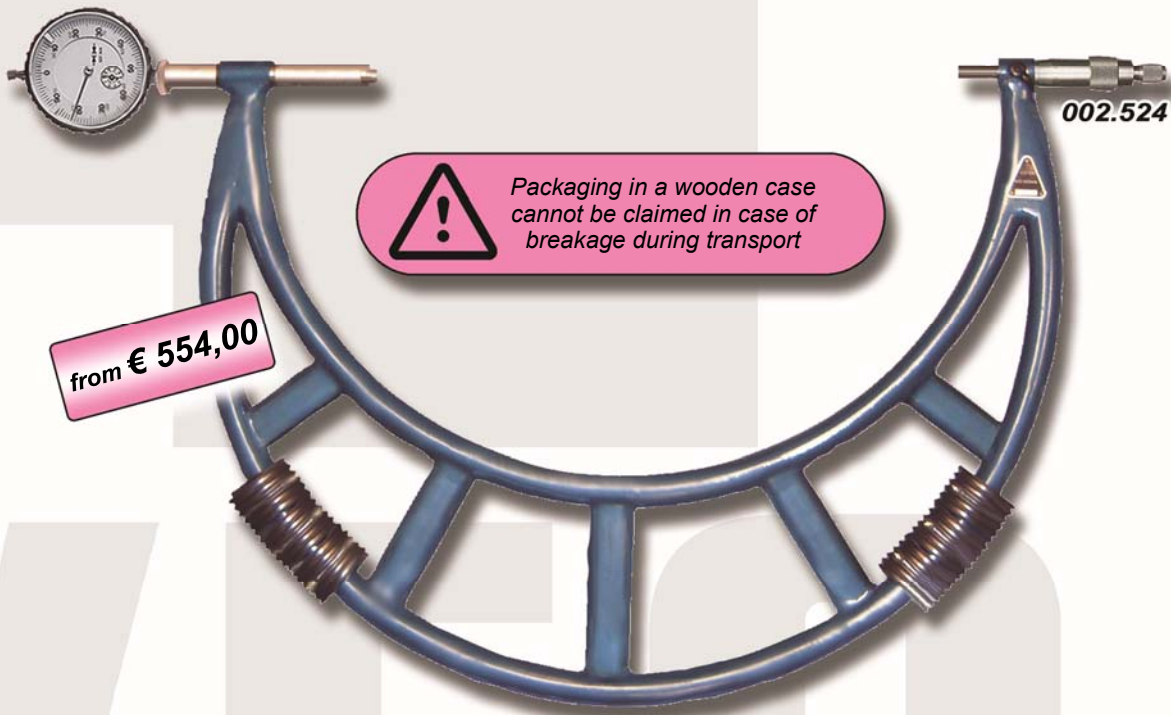

Packaging in a wooden case cannot be claimed in case of breakage during transport

from € 554,00

002.524

Code	Range	Drum	Pitch	Price €	Code	Range	Drum	Pitch	Price €
002.521	300:400	18	0,5	554,00	002.525	700:800	18	0,5	894,00
002.522	400:500	18	0,5	580,00	002.526	800:900	18	0,5	1033,00
002.523	500:600	18	0,5	656,00	002.527	900:1000	18	0,5	1171,00
002.524	600:700	18	0,5	772,00	002.530D	Perno per rimozione comparat.			34,00

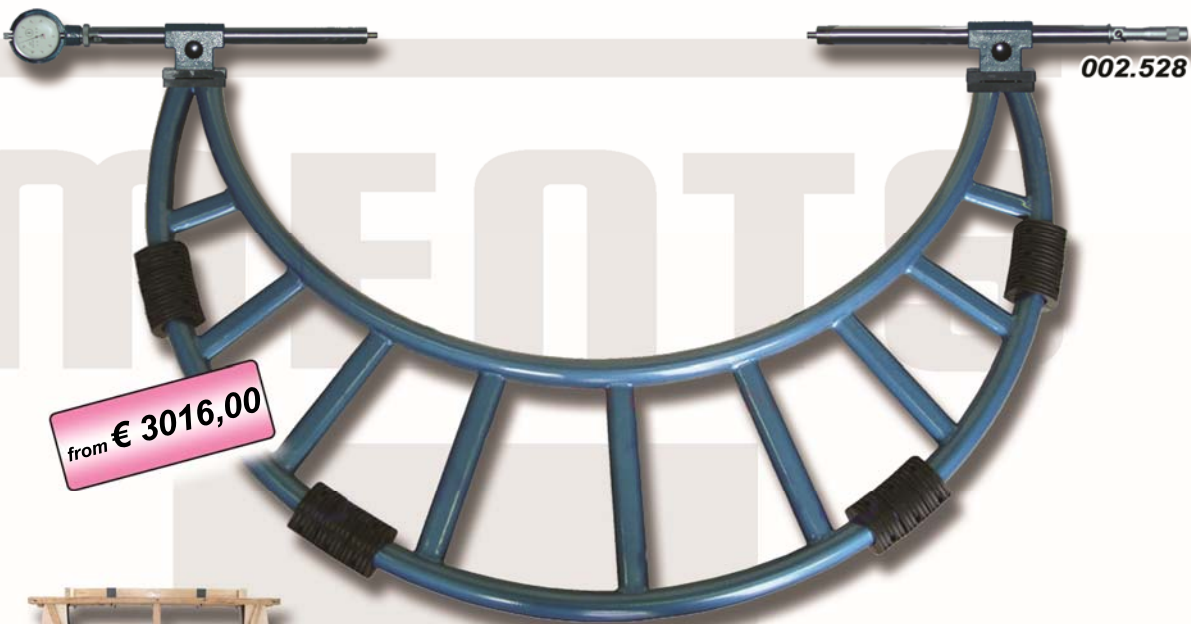

from € 3016,00

002.528



Codice 002.531 misura oltre 2500mm diventa trasporto eccezionale  
**Chiedere spesa di trasporto**

Code	Range	Drum	Pitch	Price €
002.528	1000:1500	18	0,5	3016,00
002.529	1500:2000	18	0,5	3318,00
002.530	2000:2500	18	0,5	4126,00
002.531	2500:3000	18	0,5	4396,00

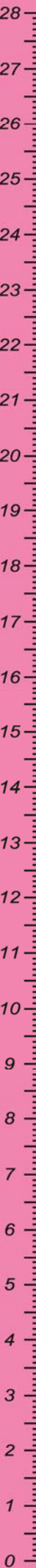

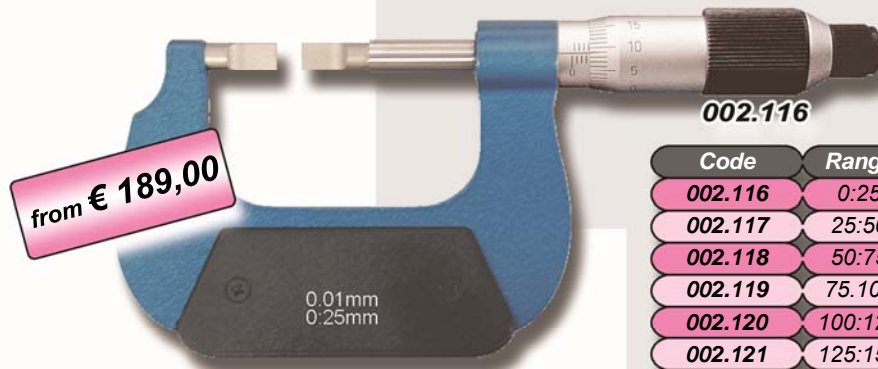

002.116

Code	Range	Contacts	Arc	Price €
002.116	0:25	0,75x6,5	37	189,00
002.117	25:50	0,75x6,5	50	205,00
002.118	50:75	0,75x6,5	62	217,00
002.119	75:100	0,75x6,5	70	248,00
002.120	100:125	0,75x6,5	82	282,00
002.121	125:150	0,75x6,5	95	296,00



009.781

Digital

009.781	0:25	0,75x6,5	37	233,00
009.782	25:50	0,75x6,5	50	251,00

Reduced contacts

002.116A	0:25	0,4x3,5	37	210,00
----------	------	---------	----	--------

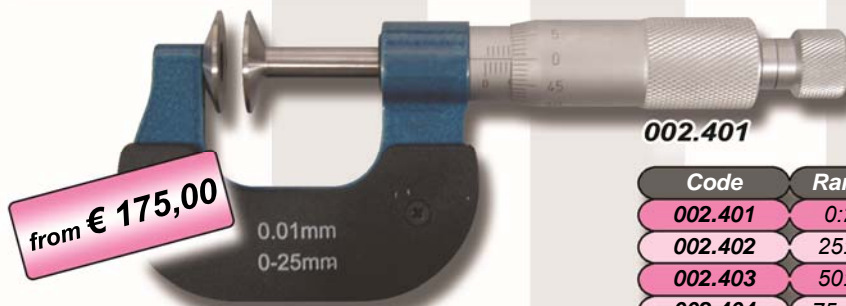

002.401

Code	Range	Disk	Arc	Price €
002.401	0:25	Ø 20	24	175,00
002.402	25:50	Ø 20	32	195,00
002.403	50:75	Ø 20	45	209,00
002.404	75:100	Ø 20	57	235,00
002.401A	0:25	Ø 30	24	224,00
002.402A	25:50	Ø 30	32	246,00
002.403A	50:75	Ø 30	45	258,00
002.404A	75:100	Ø 30	57	176,00
002.405	100:125	Ø 30	70	282,00
002.406	125:150	Ø 30	82	291,00
002.407	150:175	Ø 30	95	302,00
002.408	175:200	Ø 30	107	314,00

Spindle Ø 8 mm pitch 0.5 mm  
Without locking  
Available up to 200 mm disks Ø 30 mm



009.261

Code	Range	Disk	Arc	Price €
009.261	0:25	Ø 20	26	218,00
009.262	25:50	Ø 20	38	242,00
009.263	50:75	Ø 20	50	260,00
009.264	75:100	Ø 20	62	274,00

Spindle Ø 8 mm pitch 0.5 mm  
Available up to 200 mm disks Ø 30 mm

009.261A	0:25	Ø 30	26	282,00
009.262A	25:50	Ø 30	38	312,00
009.263A	50:75	Ø 30	50	319,00
009.264A	75:100	Ø 30	62	348,00

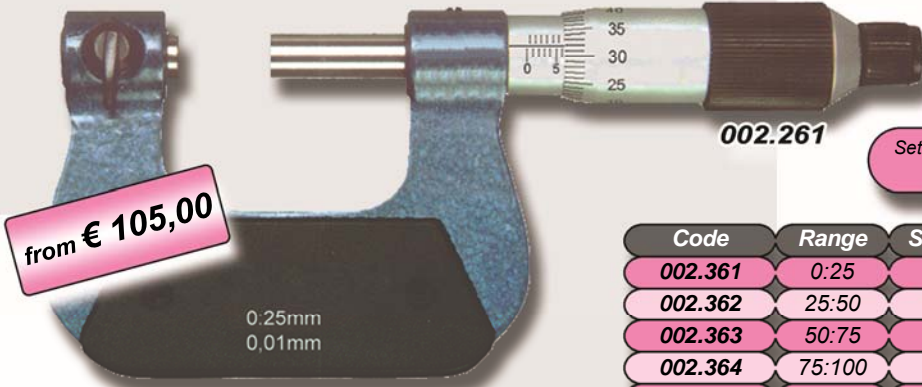

002.261

Setting rods and thread inserts Ø5x15 mm  
Not included

Code	Range	Setting	Arc	Price €
002.361	0:25	---	26	105,00
002.362	25:50	---	38	119,00
002.363	50:75	---	50	134,00
002.364	75:100	---	62	150,00
002.365	100:125	---	70	183,00
002.366	125:150	---	82	191,00
002.367	150:175	---	92	227,00
002.368	175:200	---	107	249,00

Thread inserts 55°

Code	Pitch Ww	Thread	Price €
002.399A	60-48	55°	24,00
002.399B	48-40	55°	24,00
002.399C	40-32	55°	24,00
002.399D	32-24	55°	24,00
002.399E	24-18	55°	24,00
002.399F	18-14	55°	24,00
002.399G	14-10	55°	24,00
002.399H	10-7	55°	24,00
002.399I	7-4,5	55°	24,00
002.399K	4,5-3,5	55°	24,00
002.399	10 coppie passo Ww 60-3,5		212,00

Thread inserts 60°

Code	Pitch M	Thread	Price €
002.398A	0,4-0,5	60°	24,00
002.398B	0,6-0,9	60°	24,00
002.398C	1,0-1,75	60°	24,00
002.398D	2,0-3,0	60°	24,00
002.398E	3,5-5,0	60°	24,00
002.398F	5,5-7,0	60°	24,00
002.398	6 coppie passo M 0,4-7,0		115,00

Setting rods 55°

Code	Lenght	Degrees	Price €
002.390	25	55°	41,00
002.391	50	55°	44,00
002.392	75	55°	49,00
002.393	100	55°	60,00
002.394	125	55°	69,00
002.395	150	55°	81,00
002.396	175	55°	89,00

Setting rods 60°

Code	Lenght	Degrees	Price €
002.380	25	60°	40,00
002.381	50	60°	44,00
002.382	75	60°	48,00
002.383	100	60°	59,00
002.384	125	60°	68,00
002.385	150	60°	79,00
002.386	175	60°	88,00

Precision wires for measuring threads

800.809



€ 152,00 each



001.103

Code	Code	Wire	Thread M	Pitch	Thread Ww	Unc/Unf	Trapez
Ø 6,5	Ø 8	d	rated	60°	55°	60°	30°
800.801	800.801A	0,170	M 1-1,2-1,4	0,25-0,30	---	---	---
800.802	800.802A	0,220	M 1,6-1,8	0,35	---	72	---
800.803	800.803A	0,250	M 2	0,40	60	64	---
800.804	800.804A	0,290	M 2-2,5-3	0,45-0,50	---	56	---
800.805	800.805A	0,335	M 3,5	0,60	48-40	48-44	---
800.806	800.806A	0,455	M 4-4,5-5	0,70-0,75-0,80	---	---	---
800.800	800.800A	0,530	M 5,5	0,90	32-28	32-28	---
800.807	800.807A	0,620	M 6-7	1,00	26-24	24	---
800.808	800.808A	0,725	M 8-9	1,25	22-20-19	20	---
800.809	800.809A	0,895	M 10-11	1,50	18-16	18-16	---
800.810	800.810A	1,100	M 12	1,75	14	14-13	2
800.811	800.811A	1,350	M 14-16	2,00	12-11	12-11	---
800.812	800.812A	1,650	M 18-20-22	2,50	10-9	10-9	3
800.813	800.813A	2,050	M 24-27-30-33	3,00-3,50	8-7	8-7	4
800.814	800.814A	2,550	M 36-39-42-45	4,00-4,50	6	6	5
800.815	800.815A	3,200	M 48-52-56-60	5,00-5,50	5-4½	5-4½	6



002.141

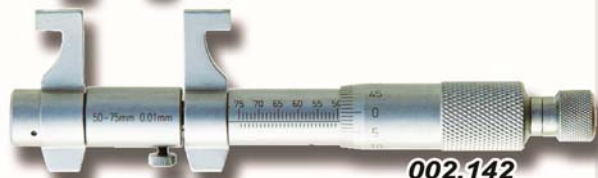

002.142

Code	Range	Ring	Price €
002.141	5:30	Ø 5	69,00
002.142	25:50	Ø 25	83,00
002.143	50:75	---	103,00
002.144	75:100	---	115,00
002.155	100:125	---	137,00
002.156	125:150	---	155,00



002.149



002.149A

Code	Range	Rings & Risc.	Price €
002.149	5:100	Ø 5+25	374,00
002.149A	5:100	Ø 5+25+75	432,00

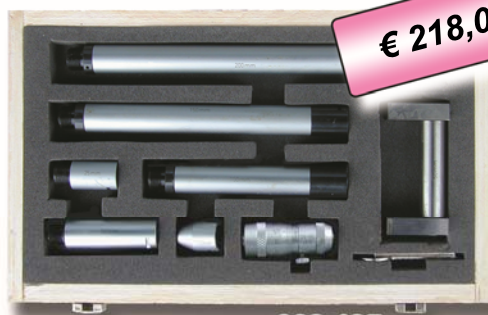

002.135

Code	Range	Rod Ø	Price €
002.135	50:600	Ø 15,5	218,00
Aste 13 - 25 - 50 - 100 - 150 - 200			

Aste di ricambio/supplemento

Code	Length	Rod Ø	Price €
002.130D	100	15,5	59,00
002.130F	200	15,5	67,00
002.130G	300	15,5	103,00



002.138

Micrometric head pitch 0.5 stroke 13 mm  
Supplied in aluminium boxes  
Rods from 13 to 300 mm

Code	Range	Rod Ø	Price €
002.138	50:1000	15,5	433,00
Aste 13 - 25 - 50 - 2x100 - 150 - 200 - 300			
002.138G	50:1500	15,5	718,00
Aste 13 - 25 - 50 - 2x100 - 150 - 2x200 - 2x300			





Code	Range	Base	Price €
009.986	0:100	100x16	201,00
009.987	0:200	100x16	327,00

Depth micrometers 0,01 - Interchangeable rods - Locking screw - 0.5 mm pitch



Code	Range	Base	Price €
002.186	0:100	100x16	135,00
002.187	0:200	100x16	201,00
002.188	0:300	100x16	237,00

Micrometric heads 0,01 and 0,001 - 25 mm stroke - Ø 12 mm shaft



Code	Range	Ø	Rotat.	Read	Price €
002.241	0:25	6,5	Si	0,01	29,00
002.241A	0:25 con foro	6,5	Si	0,01	29,00
002.242	0:25	8	Si	0,01	32,00
002.271	0:25	8	No	0,01	45,00
002.272	0:25	8	No	0,002	47,00
002.275	0:25	6,5	Si	0,001	44,00
009.281	0:25	6,5	Si	0,001	165,00

Adjustable micrometer stands - 002.201 steel - 002.203 light casting



Code	Micrometers	Opening up	Price €
002.201	<300	14	42,00
002.203	<200	21	22,00



Code	Range	Ring	Price €
002.301P	6:8	Ø 8	237,00
002.302P	8:10	Ø 8	237,00
002.303P	10:12	Ø 10	237,00
002.304P	12:16	Ø 12	226,00
002.305P	16:20	Ø 16	226,00
002.306P	20:25	Ø 20	273,00
002.307P	25:30	Ø 25	273,00
002.308P	30:40	Ø 30	320,00
002.309P	40:50	Ø 40	320,00
002.310P	50:63	Ø 50	320,00
002.311P	63:75	Ø 62	356,00
002.312P	75:88	Ø 87	380,00
002.313P	87:100	Ø 87	415,00
002.314P	100:125	---	546,00
002.315P	125:150	---	546,00

**Assortments**  
rings and extensions incl.

Code	Range	Rings	Price €
002.325P	6:12	Ø 8+10	636,00
002.326P	12:20	Ø 16	435,00
002.327P	20:50	Ø 25+40	950,00
002.328P	50:100	Ø 62+87	1402,00



Utile Inizio cod.	Analogue XT	Digital XTD	Pistol XTH
<b>Hardened contacts - Ring included</b>			
6:8	889.516	987.716	988.716
8:10	889.517	987.717	988.717
10:12,5	889.518	987.718	988.718
<b>Carbide contacts - Ring included - Throat base</b>			
12,5:16	889.519	987.719	988.719
16:20	889.520	987.720	988.720
20:25	889.521	987.721	988.721
25:35	889.522	987.722	988.722
35:50	889.523	987.723	988.723
50:65	889.524	987.724	988.724
65:80	889.525	987.725	988.725
80:100	889.526	987.726	988.726
100:125	889.527	987.727	988.727
125:150	889.528	987.728	988.728
150:175	889.529	987.729	988.729
175:200	889.530	987.730	988.730
<b>Sets - Ring/s included</b>			
6:10	889.553	987.753	988.753
10:20	889.554	987.754	988.754
20:50	889.555	987.755	988.755
50:100	889.556	987.756	988.756
100:150	889.557	987.757	988.757
150:200	889.558	987.758	988.758
6:20	---	---	988.751
20:100	---	---	988.752
100:200	---	987.759	988.759



009.521

from € 124,00

0-25mm 0.001mm

Available up to 275:300

Code	Range	Setting	Reading	Price €
009.521	0:25	---	0,001	124,00
009.522	25:50	25	0,001	146,00
009.523	50:75	50	0,001	196,00
009.524	75:100	75	0,001	231,00
009.525	100:125	100	0,001	244,00
009.526	125:150	125	0,001	258,00
009.527	150:175	150	0,001	287,00
009.528	175:200	175	0,001	315,00



009.541

from € 153,00

0-25mm 0.001mm



Range 1 turn 2 mm  
PVC friction ratchet

Available up to 175:200

Code	Range	Setting	Reading	Price €
009.541	0:25	---	0,001	153,00
009.542	25:50	25	0,001	192,00
009.543	50:75	50	0,001	226,00
009.544	75:100	75	0,001	248,00

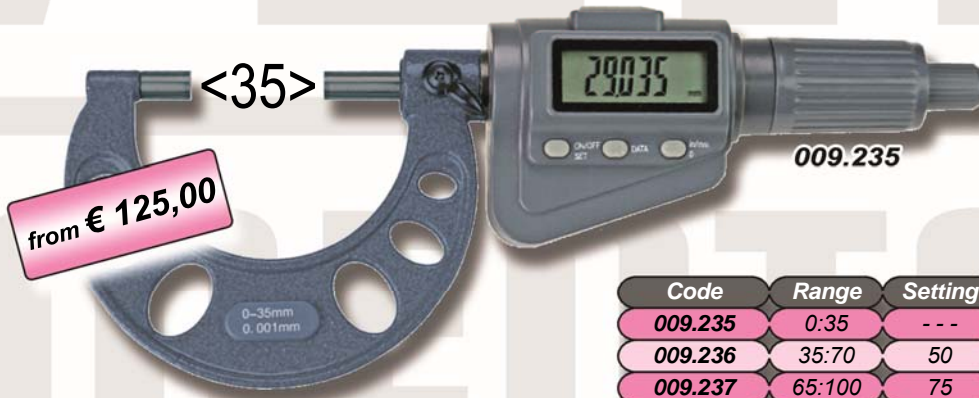

009.235

from € 125,00

<35>

0-35mm  
0.001mm

Code	Range	Setting	Arc	Price €
009.235	0:35	---	38	125,00
009.236	35:70	50	51	154,00
009.237	65:100	75	60	177,00



009.505

from € 68,00

0-25mm 0.001mm

Available up to 75:100

Code	Range	Setting	Reading	Price €
009.505	0:25	---	0,001	68,00
009.506	25:50	25	0,001	84,00



Code	Range	Setting	Arc	Price €
009.213	50:75	50	44	139,00
009.215	100:125	100	70	149,00
009.216	125:150	125	82	159,00
009.217	150:175	150	94	169,00
009.218	175:200	175	107	179,00
009.219	200:225	200	129	189,00
009.220	225:250	225	142	199,00
009.221	250:275	250	155	209,00
009.222	275:300	275	167	219,00



Rotating spindle



Code	Range	Arc	Reading	Price €
009.772	0:25(50)	37	0,001	258,00
009.774	50:75(100)	62	0,001	310,00



002.951A/J	1 pair of ball tips available from Ø 1 to Ø 6	68,00
002.939	Set 7 pcs measuring tips	153,00



Non-rotating spindle

Code	Range	Arc	Reading	Price €
009.791	0:25	26	0,001	248,00
009.792	25:50	38	0,001	259,00
009.793	50:75	50	0,001	290,00
009.794	75:100	62	0,001	318,00
009.795	100:125	70	0,001	348,00
009.796	125:150	82	0,001	381,00
009.797	150:175	92	0,001	398,00
009.798	175:200	107	0,001	434,00

Measuring tips for threads and setting rods  
see Current Promotion on page 23



from € 76,00

005.599



Code	Lenght	Reading	Price €
005.599	150	0,05°	76,00
Flat ground steel base without magnets			



€ 101,00

005.598



Code	Lenght	Reading	Price €
005.598	150	0,05°	101,00
Semi-prismatic aluminium base with 2 magnets			



005.542

Code	Range	Accuracy	Price €
005.541	150x150	0,02	256,00
005.542	200x200	0,02	269,00
005.545	150x150	0,05	240,00
005.546	200x200	0,05	257,00



005.442

from € 146,00

Code	Range	Accuracy	Price €
005.441	150	0,02	163,00
005.442	200	0,02	185,00
005.444	300	0,02	237,00
005.445	150	0,05	146,00
005.446	200	0,05	175,00

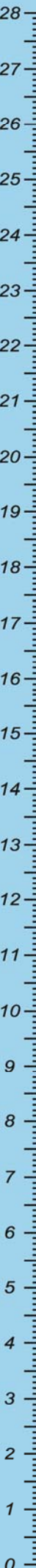



€ 97,00

003.068

Code	Range	Blades	Price €
003.068	4x90°	150-200-300	97,00
With clock 5'			



€ 89,00

003.066

Code	Range	Blades	Price €
003.066	4x90°	150-200-300	89,00
Vernier 5' with magnifying glass			



€ 349,00

003.995

Code	Range	Blades	Price €
003.995	90°-180°-360°	150-200-300	349,00
003.994	Additional blade 500		37,00
Digital with double reading 1' or 0.01°			



from € 23,00

006.101

Code	Range	Vernier	Price €
006.101	200	0,1	23,00
006.102	250	0,1	26,00
006.103	300	0,1	27,00



006.118

006.118	200	0,05	29,00
006.119	400	0,05	50,00
006.118P	Replacement carbide tip		5,00



from € 15,00

003.351

003.352

Codice	Height	Base	Price €
003.351	100	70	15,00
003.352	150	100	18,00
003.353	200	130	22,00
003.354	250	160	26,00
003.355	300	180	31,00
003.356	400	210	43,00
003.357	500	260	47,00

Standard bevel protractors - Chromium-plated - Laser-engraved scale - Reading 1°

Catalogue 3/9

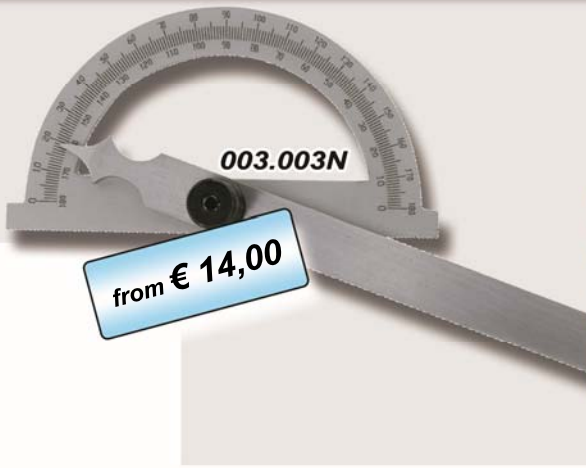

Code	Arc Ø	Scale	Price €
003.001N	80	120	14,00
003.002N	120	150	19,00
003.003N	150	200	28,00
003.004N	200	300	38,00
003.005N	250	500	70,00
003.006N	300	600	99,00

Available up to 400x1000 mm

Bevel protractors with moveable blade - Chromium-plated - Laser-engraved scale - Reading 1°

Catalogue 3/9



Code	Arc Ø	Scale	Price €
003.011N	100	150	33,00
003.012N	150	300	39,00
003.013N	200	400	46,00
003.014N	250	500	66,00
003.015N	300	600	80,00

Standard digital protractors - Reading 0.05° - Range 0-180°

Catalogue 3/11



Code	Base	Scale	Price €
009.811	120	150	64,00
009.812	150	200	74,00
009.813	200	300	87,00

Available up to 400x1000 mm

Digital squares - Reading 0.05° - Laser-engraved graduated scales - Range 0-180°

Catalogue 3/11

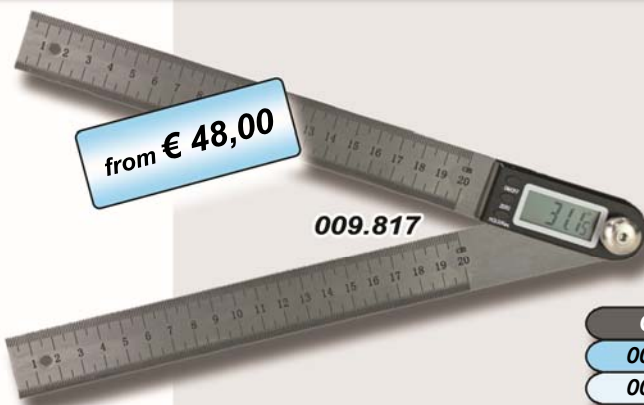

Code	Base	Scale	Price €
009.817	200	200	48,00
009.818	300	300	54,00

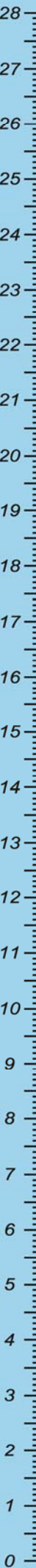

Catalogue 4A/6

Dial gauges 0,01 - 004.006 Knurled ring Ø 40 mm - 004.010 Knurled ring Ø 58 mm



004.006



004.010

€ 17,00

Code	Range	Knurled	Reading	Price €
004.006	0:5	Ø40	0,01	26,00
004.010	0:10	Ø58	0,01	17,00

Catalogue 4A/8

Dial gauges 0,01 - Knurled ring Ø 58 mm - 004.010N New special black model



004.010N



004.014

€ 26,00

Code	Range	Knurled	Reading	Price €
004.010N	0:10	Ø58	0,01	28,00
0:10 New special model with black dial				
004.014	0:10	Ø58	0,01	26,00
Shockproof device with yellow dial				

Catalogue 4A/15

Dial gauges 0,01 - Concentric needles - Wide range



004.037

from € 78,00

Code	Range	Knurled	Reading	Price €
004.037	0:30	Ø58	0,01	78,00
004.039	0:50	Ø58	0,01	124,00
004.038	0:80	Ø58	0,01	224,00

Catalogue 4A/5

Dial gauges 0,1 - 1 turn = 10 mm - Dial Ø 58 mm



004.041

from € 28,00

Code	Range	Knurled	Reading	Price €
004.041	0:10	Ø58	0,1	28,00
004.043	0:30	Ø58	0,1	49,00



Dial gauges 0,01 - Knurled ring Ø 40 or 58 mm - Concentric needles - Metal frame

Catalogue 4A/7



702.045

from € 34,00

702.058

Code	Range	Knurled	Reading	Price €
702.045	0:10	Ø40	0,01	36,00
702.058	0:10	Ø58	0,01	34,00

Original Käfer dial gauges 0,01 - Special promotional series

Catalogue 4A/10



701.200

from € 46,00

701.100



Code	Range	Knurled	Reading	Price €
701.200	0:10	Ø58	0,01	46,00

Code	Range	Knurled	Reading	Price €
701.100	0:10	Ø58	0,01	63,00

Metal knurled ring, dust cap and ruby contact point

Dial gauges 0,01 - Splash-proof with screwed knurled ring - Rod cover bellows

Catalogue 4A/13



004.708

€ 58,00



Splash-proof

Code	Range	Knurled	Reading	Price €
004.708	0:10	Ø61,5	0,01	58,00

Dial gauges 0,001 - Range 1 mm or 5 mm - Dial Ø 58 mm

Catalogue 4A/16



004.051

from € 76,00

004.053

Code	Range	Strokes	Reading	Price €
004.051	0:1	100	0,001	76,00
004.053	0:5	200	0,001	82,00

Catalogue 4A/21

Digital dial gauges - 0.01 mm/inch (004.901 with memory function)



Code	Range	Reading	Accuracy	Price €
004.945	0:12	0,01	±0,04	58,00

Catalogue 4A/20

Digital dial gauges 0.01 or 0.001 - ABS-Inc-Tol (\*) or Preset ± (\*\*) functions



Code	Range	Reading	Accuracy	Price €
004.948*	0:12	0,01	±0,02	92,00
004.949*	0:25	0,01	±0,03	137,00
004.950*	0:50	0,01	±0,04	199,00
004.975*	0:12	0,001	±0,015	105,00
004.981*	0:12	0,001	±0,009	112,00
004.986*	0:12	0,001	±0,005	163,00

Code	Range	Reading	Accuracy	Price €
004.968**	0:12	0,01	±0,02	89,00
004.980**	0:12	0,001	±0,009	112,00
004.985**	0:12	0,001	±0,005	163,00
004.969**	0:25	0,01	±0,02	116,00

Catalogue 4A/21

Digital dial gauges 0.01 or 0.001 - ABS-Tol-Preset functions ±



Data socket

Don't lose the measure when turned off

Code	Range	Reading	Accuracy	Price €
004.951	0:12	0,01	±0,02	118,00
004.952	0:25	0,01	±0,03	158,00
004.953	0:50	0,01	±0,04	245,00

Code	Range	Reading	Accuracy	Price €
004.959	0:12	0,001	±0,002	167,00
004.959A	0:25	0,001	±0,03	209,00
004.959B	0:50	0,001	±0,04	389,00

Out of catalogue

Quick measuring gauges 0,1 - Ball contact points Ø 2 mm - Reading 0.1 mm



Code	Range	Reading	Arms	Price €
004.631	0:10	0,1	36mm	23,00



from € 139,00

004.506

Bore gauge set with digital dial gauge

Code	Range	Depth	Price €
004.501	6:10	45	139,00
004.502	10:18	100	139,00
004.503	18:35	150	139,00
004.504	35:50	150	139,00
004.514	35:70	150	176,00
004.506	50:160	150	139,00
004.526	50:160	500	255,00
004.507	160:250	400	168,00
004.508	250:450	400	183,00
Set 004.555	18:160	150	359,00
Set 004.556	18:160	150	453,00

Bore gauges - New domestic production - Dial gauges excluded



from € 249,00

520.105L

Code	Range	Depth	Price €
520.101	15:35	175	259,00
520.102	30:100	250	249,00
520.102L	30:125	250	269,00
520.103	50:160	250	299,00
520.104	50:210	380	329,00
520.104L	50:265	380	359,00
520.105	100:300	350	479,00
520.105L	100:500	350	549,00
520.106	100:500	650	749,00
520.107	190:1000	650	1199,00

Schwenk bore gauges RA series (Rabito) - Hardened steel contact pins - Dial gauges excluded

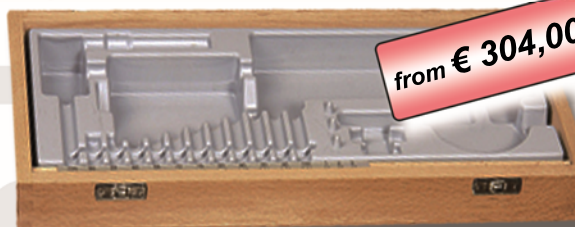

from € 304,00

530.603

Max. error 3 micron



Code	Range	Depth	Price €
531.601	18:35	180	315,00
531.602	35:60	180	304,00
531.603	50:150	180	354,00
531.604	150:300	180	629,00
Set 531.610	18:150	See above	614,00

Schwenk bore gauges SU series (Subito) - Carbide contact pins - Dial gauges excluded



from € 547,00

531.107

Ideal with 1000-division dial gauges

Max. error ±2 µm - up to 160:290 over ±3 µm -

Code	Range	Depth	Price €
531.102	6:8	100	867,00
531.103	8:12	100	824,00
531.104	12:20	100	547,00
531.105	18:35	110	581,00
531.106	35:60	177	559,00
531.107	50:100	177	638,00
531.108	100:160	234	828,00
531.109	160:290	234	1089,00
531.110	280:410	400	2531,00



Code	Range	Dial	Contact	Price €
004.104	0:0,8	Ø38	L 16	55,00
004.105	0:0,8	Ø32	L 16	55,00



Code	Range	Dial	Contact	Price €
004.118	0:0,8	Ø38	L 30	95,00
004.119	0:0,8	Ø32	L 30	95,00



Code	Range	Dial	Contact	Price €
004.111	0:0,8	Ø32	L 12	66,00



Code	Range	Dial	Contact	Price €
004.209	0:0,2	Ø32	L 14	88,00



Code	Range	Dial	Contact	Price €
714.101	0:0,8	Ø32	L 12,8	128,00
714.102	0:0,8	Ø40	L 12,8	132,00

Code	Range	Dial	Contact	Price €
714.107	0:0,5	Ø32	L 35,7	181,00
714.108	0:0,5	Ø40	L 35,7	184,00

Dial test indicators 0,01 - Shape A - 30° inclined dial

Out of catalogue



30° inclined dial for easy reading

Code	Range	Dial	Contact	Price €
004.115	0:0,8	Ø30	L 16,5	72,00
004.114	0:0,8	Ø38	L 16,5	77,00

Dial test indicators 0,01 , long range and rev. counter - Shape A - 30° inclined dial

Out of catalogue



Ø 4 swivel 160° stems

150° rotary tips

30° inclined dial for easy reading

Code	Range	Dial	Contact	Price €
004.125	0:1,6	Ø30	L 16,5	112,00
004.124	0:1,6	Ø38	L 16,5	114,00

Dial test indicators 0,002 - Shape A - Accessories for touch probes

Catalogue 4A/27



Code	Range	Dial	Contact	Price €
714.201	0:0,2	Ø32	L 12,8	155,00
714.202	0:0,2	Ø40	L 12,8	158,00

714.997	as 714.998 + CDR integrated			39,00
714.998	Half round support Ø8 - holes Ø4 and Ø8 mm			23,00



Code	Vertical	Crossbar	Kg/thread	Price €
004.261	Ø12/175	Ø10/150	60/M8	29,00
004.261-8	Ø12/175	Ø10/150	80/M8	33,00
004.377	Ø16/230	Ø14/200	100/M8	48,00
Without micrometer head				

Code	Vertical	Crossbar	Kg/thread	Price €
004.263	Ø12/175	Ø10/150	60/M8	33,00
004.263-8	Ø12/175	Ø10/150	80/M8	36,00
004.276	Ø16/230	Ø14/200	100/M8	51,00
With micrometer screw				



Code	Vertical	Crossbar	Kg/thread	Price €
004.226	Ø16/210	Ø16/210	60/M10	77,00
004.227	Ø20/360	Ø16/210	120/M12	126,00
004.228	Ø20/420	Ø16/390	80/M12	124,00
004.229	as 004.227 with 2 crossbars			119,00
With micrometer screw				



Code	Dimensions	Magnet type	Price €
004.217	36x30x35	30kg M5	12,00
Code	H with magn.	Magnet	Price €
004.221	145+35	30kg M5	44,00
004.222	290+55	60Kg M8	54,00
004.223	365+55	60kg M8	69,00

Articulated dial gauge support - Central locking



Code	H with magn.	Magnet	Price €
004.286	270+55	80kg M8	163,00
004.286 cardboard box set			
004.288	380+55	100kg M8	199,00
004.288 aluminium box set			
004.288C4	Dial gauge Ø58 - Touch test probe Ø40 Half round meas. Support Ø4+Ø8 - Extension 200		329,00

Code	H with magn.	Magnet	Price €
004.215	350+55	60kg M8	69,00
004.215-8	350+55	80kg M8	75,00



Code	Radius	Magnet	Price €
004.295	200	80kg M8	199,00
Same as catalogue code 428.601			

Code	Radius	Magnet	Price €
004.305	280	100kg M8	239,00
Same as catalogue code 430.601			

Code	Radius	Magnet	Price €
004.311	400	100kg M8	269,00
Same as catalogue code 429.601			



Code	Radius	Magnet	Price €
004.245	200	80kg M8	229,00
Same as catalogue code 424.601			

Code	Radius	Magnet	Price €
004.256	280	100kg M8	309,00
Same as catalogue code 420.602			





Complete range on  
www.ileveninstruments.com



440.912

**Kroeplin**  
Längenmesstechnik

Code	Range	Type	Arms	Price €
440.912	5:15	H 105	35	request
440.941	10:30	H 210	85	request
440.942	20:40	H 220	85	request
440.943	30:50	H 230	85	request
440.944	40:60	H 240	85	request
440.945	50:70	H 250	85	request
440.946	60:80	H 260	85	request
440.947	70:90	H 270	85	request
440.948	80:100	H 280	85	request

Complete range on  
www.ileveninstruments.com



941.941

G until stocks finish

**Kroeplin**  
Längenmesstechnik

Code	Range	Type	Arms	Price €
943.002	5:20	G 005	44	request
941.911	2,5:12,5	L 102	12	request
9741.912	5:15	L 105	35	request
941.941	10:30	L 210	85	request
941.942	20:40	L 220	85	request
941.943	30:50	L 230	85	request
941.944	40:60	L 240	85	request
941.945	50:70	L 250	85	request
941.946	60:80	L 260	85	request
941.947	70:90	L 270	85	request
941.948	80:100	L 280	85	request
941.955	16:55	G 415	188	request

Complete range on  
www.ileveninstruments.com



961.953

C until stocks finish

**Kroeplin**  
Längenmesstechnik

Code	Range	Type	Arms	Price €
961.953	0:20	K 220	85	request
961.955	0:30	K 330	116	request
961.957	0:50	C 450	167	request



from € 153,00

510.047



Calibration certificate supplements D1 (1 point)

Code	Pieces	Comp	Grades	Price €
C005.032	32 pcs	A	0-1-2	249,00
C005.047	47 pcs	B-C	0-1-2	365,00
C005.087	87 pcs	D	0-1-2	681,00



Calibration certificate supplements D2 (5 points)

Code	Pieces	Comp	Grades	Price €
C555.032	32 pcs	A	0-1-2	300,00
C555.047	47 pcs	B-C	0-1-2	443,00
C555.087	87 pcs	D	0-1-2	820,00

Composition table of gauge block series

Comp. A	Pitch	No.
1,005	---	1
1,01 - 1,09	0,01	9
1,1 - 1,9	0,1	9
1 - 9	1	9
10 - 30	10	3
50	50	1

Comp. B	Pitch	No.
1,005	---	1
1,01 - 1,19	0,01	19
1,2 - 1,9	0,1	8
1 - 9	1	9
10 - 100	10	10

Comp. C	Pitch	No.
1,005	---	1
1,01 - 1,09	0,01	9
1,1 - 1,9	0,1	9
1 - 24	1	24
25 - 100	25	4

Comp. D	Pitch	No.
1,001 - 1,009	0,001	9
1,01 - 1,49	0,01	49
0,5 - 9,5	0,5	19
10 - 100	10	10

Code	Pieces	Grade	Price €
Composition A			
510.032	32 pcs	0	399,00
511.032	32 pcs	1	258,00
512.032	32 pcs	2	153,00

Code	Pieces	Grade	Price €
Composition B			
510.047	47 pcs	0	546,00
511.047	47 pcs	1	380,00
512.047	47 pcs	2	203,00

Code	Pieces	Grade	Price €
Composition C			
511.048	47 pcs	1	391,00

Code	Pieces	Grade	Price €
Composition D			
510.087	87 pcs	0	759,00
511.087	87 pcs	1	476,00
512.087	87 pcs	2	293,00

Gauge block precision table

Rated meas. in mm	Up to
More than	10
10	25
25	50
50	75
75	100

Grade 0	
Deviation µm	Flatness µm
± 0,12	0,10
± 0,14	0,10
± 0,20	0,10
± 0,25	0,12
± 0,30	0,12

Grade 1	
Deviation µm	Flatness µm
± 0,20	0,16
± 0,30	0,16
± 0,40	0,18
± 0,50	0,18
± 0,60	0,20

Grade 2	
Deviation µm	Flatness µm
± 0,45	0,30
± 0,60	0,30
± 0,80	0,30
± 1,00	0,35
± 1,20	0,35



from € 1289,00

521.047

Code	Pieces	Grade	Price €
Composition B			
521.047	47 pcs	0	1623,00
522.047	47 pcs	1	1289,00
Composition C			
521.048	47 pcs	0	1623,00
522.048	47 pcs	1	1289,00



from € 702,00

513.108



€ 101,00

513.000

513.000 Gauge block connector over 101,00

Composition table of gauge block series

Comp. K	Pitch	No.
25 - 200	25	8

Comp. L	Pitch	No.
125 - 200	25	4
250	---	1
300 - 500	100	3

Precision table for long gauge blocks

Rated meas. in mm	
More than	Up to
100	150
150	200
200	250
250	300
300	400
400	500
500	600

Grade 0	
Deviation $\mu\text{m}$	Flatness $\mu\text{m}$
$\pm 0,40$	0,14
$\pm 0,50$	0,15
$\pm 0,60$	0,16
$\pm 0,70$	0,19
$\pm 0,90$	0,20
$\pm 1,10$	0,25
$\pm 1,30$	0,25

Grade 1	
Deviation $\mu\text{m}$	Flatness $\mu\text{m}$
$\pm 0,80$	0,20
$\pm 1,00$	0,25
$\pm 1,20$	0,25
$\pm 1,40$	0,30
$\pm 1,90$	0,30
$\pm 2,20$	0,35
$\pm 2,60$	0,40

Grade 2	
Deviation $\mu\text{m}$	Flatness $\mu\text{m}$
$\pm 1,60$	0,40
$\pm 2,00$	0,40
$\pm 2,40$	0,45
$\pm 2,80$	0,50
$\pm 3,60$	0,50
$\pm 4,40$	0,60
$\pm 5,00$	0,70

Code	Pieces	Grade	Price €
Composition K			
514.008	8 pcs	0	1004,00
514.108	8 pcs	1	702,00
C514.008	Accredia cert. Supplement		679,00
Composition L			
513.008	8 pcs	0	1843,00
513.108	8 pcs	1	1204,00
C513.008	Accredia cert. Supplement		735,00

Gauge blocks with rings - Checking calipers and micrometers



from € 230,00

515.010

516.204

Code	Pieces	Grade	Price €
10 pcs set for micrometers 0:25			
2,5 - 5,1 - 7,7 - 10,3 - 12,9 - 15,0 - 17,6 - 20,2 - 22,8 - 25,0			
515.010	10 pcs	1	230,00
C515.010	Accredia cert. Supplement		99,00

Code	Pieces	Grade	Price €
Set 3+2 pcs for calipers 0:200			
Gauge blocks 30,0 - 41,3 - 131,4 - Rings $\varnothing 4 - \varnothing 25$			
516.204	5 pcs	1	245,00
C516.254	Dakks cert. Supplement		322,00

Angle gauge blocks - Checking squares and protractors

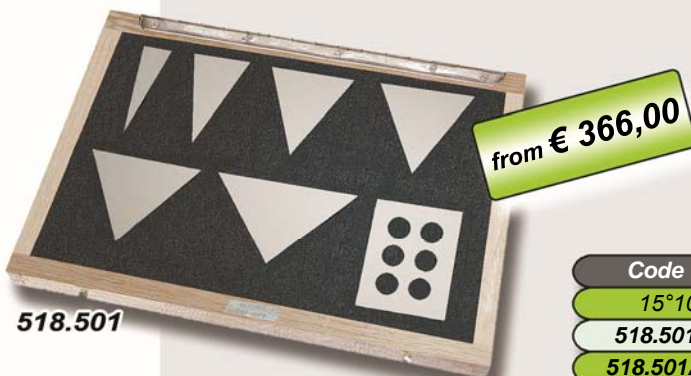

from € 366,00

518.501

Code	Pieces	Grade	Price €
15°10' - 30°20' - 45°30' - 50° - 60°40' - 75°50' - 90°			
518.501	7 pcs	1	489,00
518.501A	7 pcs	2	366,00



006.708

Pins with sizes 10 to 20 without size separator  
Loose in the package with plastic sleeve only  
From 006.711 to 006.720 + 006.761-006.762  
The colour of the wood of the boxes may vary



006.717

Assortments 0.01 up to 1 mm

Code	Range	Pins	Prog.	Price €
006.697	0,2:0,5	31	0,01	107,00
006.698	0,2:1	81	0,01	216,00
006.699	0,5:1	51	0,01	182,00

Assortments 0.01 from 1 to 10 mm

Code	Range	Pins	Prog.	Price €
006.702	1,01:2	100	0,01	291,00
006.703	2,01:3	100	0,01	291,00
006.704	3,01:4	100	0,01	291,00
006.705	4,01:5	100	0,01	303,00
006.706	5,01:6	100	0,01	303,00
006.707	6,01:7	100	0,01	311,00
006.708	7,01:8	100	0,01	311,00
006.709	8,01:9	100	0,01	322,00
006.710	9,01:10	100	0,01	322,00

Assortments 0.01 from 10 to 20 mm

Code	Range	Pins	Prog.	Price €
006.711	10,01:11	100	0,01	387,00
006.712	11,01:12	100	0,01	387,00
006.713	12,01:13	100	0,01	396,00
006.714	13,01:14	100	0,01	460,00
006.715	14,01:15	100	0,01	460,00
006.716	15,01:16	100	0,01	522,00
006.717	16,01:17	100	0,01	522,00
006.718	17,01:18	100	0,01	582,00
006.719	18,01:19	100	0,01	593,00
006.720	19,01:20	100	0,01	612,00

Assortments 0,1

Code	Range	Pins	Prog.	Price €
006.700	1:10	91	0,1	286,00
006.761	10:16	61	0,1	269,00
006.762	16:20	41	0,1	269,00

New

Clamps and pin gauge holder sets - For Measuring pins



636.809

from € 25,00



636.710

Code	Min $\varnothing$	Max $\varnothing$	Dimens.	Price €
636.801	0,28	1,51	$\varnothing$ 19L107	25,00
636.802	1,52	7,71	$\varnothing$ 28L140	33,00
636.803	7,72	12,71	$\varnothing$ 39L157	44,00
636.804	12,72	15,31	$\varnothing$ 33L148	54,00
636.805	15,32	17,81	$\varnothing$ 43L154	58,00
636.806	17,82	20,37	$\varnothing$ 45L154	68,00
Codice	Min $\varnothing$	Max $\varnothing$	Price €	
636.809	0,28	20,37	179,00	
636.809 Complete set of 6 pin gauge holders in aluminium case				
636.710	1,0	13,00	29,00	
636.711	13,00	20,00	33,00	



For the whole range of individual pads or series see dedicated promotion

Code	Pad Ø	Pieces	Price €
Aluminium or plastic boxes			
575.002Q	3:12	7 pcs	167,00
575.000Q	3:30	28 pcs	765,00
575.001Q	32:62	16 pcs	912,00



For the whole range of individual pads or series see dedicated promotion

Boxes of 7 or 21 rings are available on request  
Go (pass) or No Go (does not pass)

Code	Pad Ø	Pieces	Price €
Aluminium or plastic boxes			
572.100	3:12	7 pcs	159,00
572.000	3:14	13 pcs	248,00
572.200	2:30	21 pcs	583,00



For the whole range of balls see dedicated promotion

Code	No. of pairs	Range	Price €
006.690	25	Ø01-25	121,00



Code	Description	Price €
410.350	Filetor	82,00
410.351	Tolerator	82,00
410.352	Converter	59,00

009.699



from € 479,00

Connecting a dial gauge from 004.95 series... the display of the height gauge shows the sum of the 2 instruments



009.697

004.951

009.693

Code	Accessories	Price €
009.697	Calble height gauge to dial gauge	22,00

Code	Range	Reading	Accuracy	Price €
Dial gauges catalogue 4A/21 rev. and promotion, page 34				
004.951	0:12	0,01	10 µm	118,00

Height gauges, scriber and dial gauge holder included, optionally available with round scriber

Code	Accessories	Price €
009.699	P.ta tonda 87x37 attacco 8,5x9	50,00

Code	Range	Reading	Price €
On/off - mm/inch - zero - hold - inc - origin			
009.693	300	0,01	479,00
009.696	600	0,01	759,00

from € 249,00

from € 399,00



009.653

009.683

Code	Range	Reading	Price €
On/off - mm/inch - zero - preset+/- ABS - hold			
009.653	300	0,01/inch	249,00
009.655	500	0,01/inch	399,00
009.660	1000	0,01/inch	999,00

Code	Range	Reading	Price €
On/off - mm/inch - zero - preset+/-			
009.683	300	0,01/inch	399,00
009.685	600	0,01/inch	669,00



from € 46900

from € 269,00

Code	Range	Reading	Price €
<i>Dual analogue indicator and 100-division dial gauge</i>			
006.023	300	mm + 0,01	269,00
006.026	600	mm + 0,01	459,00

Code	Range	Reading	Price €
<i>On/off - mm/inch - zero - preset+/-</i>			
009.023	300	0,01/inch	469,00
009.026	600	0,01/inch	729,00
009.826E	600	0,01/inch	659,00

009.023

006.023

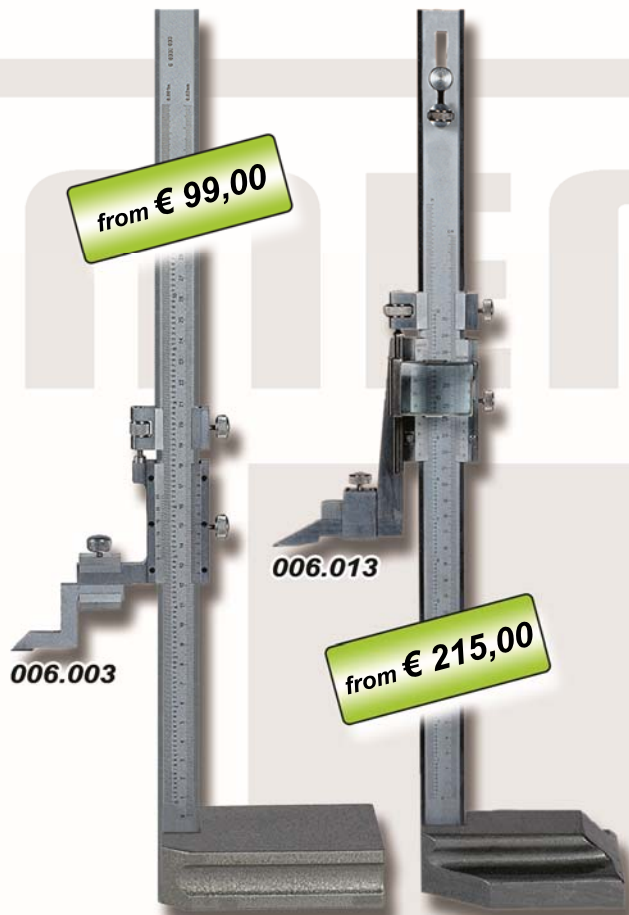

from € 99,00

from € 215,00

Code	Range	Reading	Price €
<i>Vernier may vary depending on stock availability</i>			
006.003	300	0,02 (0,05)	99,00
006.005	500	0,02 (0,05)	179,00
006.010	1000	0,02 (0,05)	599,00

Code	Range	Reading	Price €
<i>Less expensive version of 006.013</i>			
006.043	300	0,02	134,00

Code	Range	Reading	Price €
<i>Adjustable rod - Lens - Micrometric head</i>			
006.013	300	0,02	215,00
006.016	600	0,02	329,00

006.003

006.013

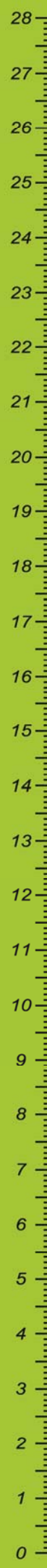

New

Mini Platon Demm comparison gauges - For interior/exterior use - 2 attachment systems

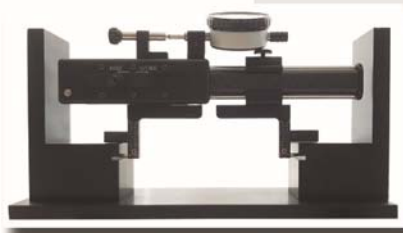

Possible application

Code	Interior	Exterior	Rod	Price €
224.200	0:290	32:320	265	request

- Digital caliper with internal/external comparison with preload
- Aluminum body and carbon rod
- Interchangeable tips and jaws
- Double dial gauge attachment system (fig. 1 & 2)
- Standard: beaks BEC35 and BEC35L, supports APM and APF
- Height adjustable, dial gauge Ø 60mm 0,01
- Useful preload stroke 20 mm

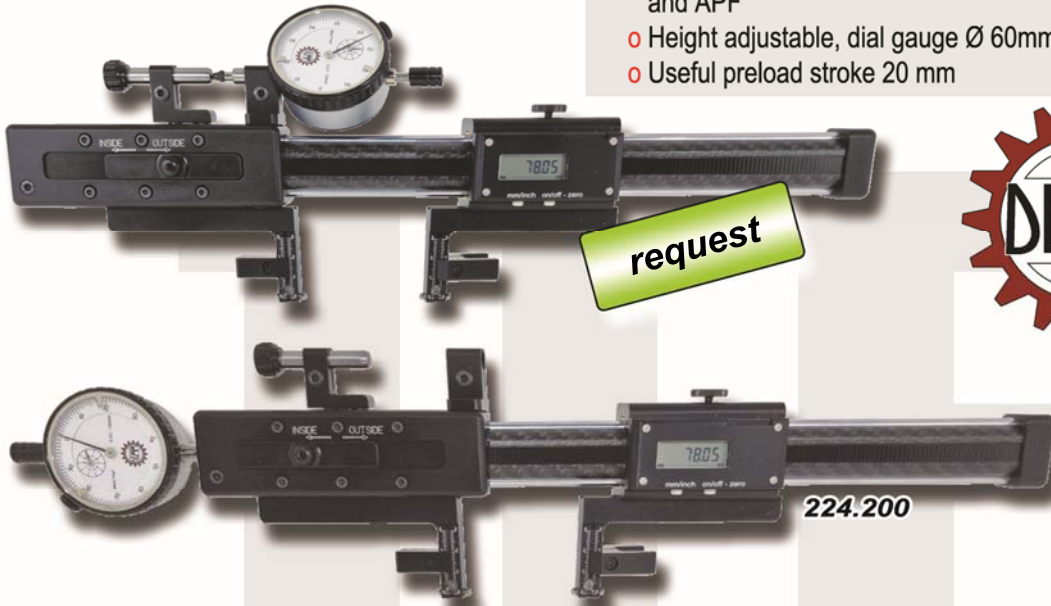

request



224.200

New

Idra Demm digital slide meters - Tubular column - Double carriage - Push or pull



request

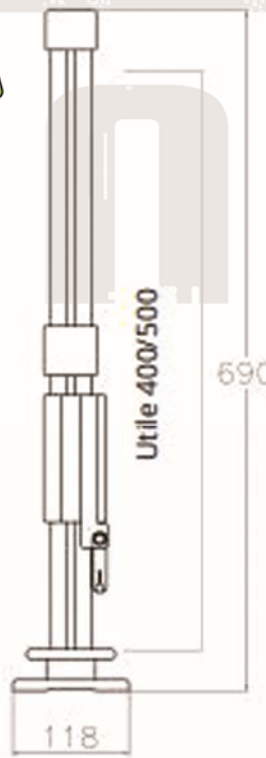

Code	Range	Base	Resol.	Price €
009.692	400:500	149x118	0,01	request

- Digital measuring device for heights, pull and push with loading spring
- Tubular column with high rigidity, guarantees a very accurate precision and fluency
- Double carriage for preloading for push and pull measurements
- Sliding system on bearings, counterweight for balancing
- Hardened steel base 50 HRC
- IP54 electronics with OPTO/RS232 or OPTO/USB data output



009.692



Digital measuring wheels - Useful travel 10,000 meters - LCD display

New



985.501

Code	Range	Accuracy	Digital	Price €
985.501	0:10000	<0,5%	Si	93,00

Brix refractometer 0-32% - Adjustable monocular - Protected zeroing screw

New



985.600

Code	Range	Grad.	Accuracy	Price €
985.600	0:32%	0,1/0,2%	±0,2%	93,00

Precision dual scale tape measures - Digital (985.515) - Class I or II

New



985.515

958.511

Code	Range mt	Sec. mm	Class	Price €
985.510	3	19	II	8,00
985.511	5	27	II	15,00
985.512	10	27	II	26,00
985.513	3	19	I	19,00
985.515	5	19	I	62,00

Infrared meters - With laser pointer - Useful 80 meters

New



985.530

Code	Range mt	Resol.mt	Protec.	Price €
985.530	0:80	0,001/0,01	NO IP	179,00

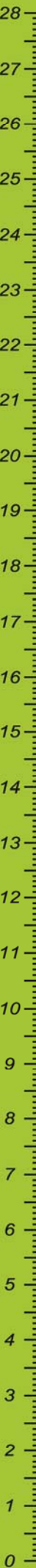



Max. 600 rpm

Code	Shank	Cont. Ø	Lenght	Price €
Edge finders with burnished finish				
009.681	Ø10	10	90	14,00
009.682	Ø10	10+4	90	15,00
Edge finders with ground finish				
009.671	Ø10	10	90	23,00
009.672	Ø10	10+4	90	24,00



Max. 600 rpm

Code	Shank	Cont. Ø	Lenght	Price €
Edge finders non-magnetic TIN coating				
653.096	Ø10	10	90	49,00
653.097	Ø10	10+4	90	49,00
Ceramic edge finders non-magnetic				
653.091	Ø10	10	90	24,00
653.093	Ø10	10	90	49,00

New



Code	Shank	Cont. Ø	Lenght	Price €
Edge finders stainless steel				
653.301	Ø10	10	90	28,00
653.302	Ø10	10+4	90	28,00
Edge finders non-magnetic TIN coating				
653.303	Ø10	10	90	90,00
653.304	Ø10	10+4	90	108,00



Do not rotate them on the machine!!!

Code	Shank	Ball	Lenght	Price €
009.659	Ø20	Ø10	100	79,00
009.662	Ø20	Ø10	160	89,00
009.663	Ø20	Ø10	160	99,00

Tschorn edge finders 2D or 3D - With red LED and/or Beep - No liquid protection

New

3D 2D Beep for drilling machines



653.201 653.202 653.203 653.204

from € 109,00

**T SCHORN®**

Code	Shank	2D/3D	Type	Price €
653.201	Ø20	3D	LED	159,00
653.202	Ø20	2D	LED/Beep	109,00
653.203	Ø18	2D	LED	177,00
653.204	Ø25	2D	LED	177,00

Height preset - Dial gauge Ø 40 - Built-in or lever magnets (h 100)

Catalogue 8/8



009.642

009.648

h 50 permanent magnet  
h 100 lever magnet

from € 114,00

Code	Body	Plate	Height	Price €
Reset with 2 built-in 50/100 setting pins				
009.648	57x65	Ø26	50	114,00
009.649	65x83	Ø26	100	201,00

Code	Body	Plate	Height	Price €
Zeroing with "preset" side wheel				
009.641	57x59	Ø32	50	176,00
009.642	58x80	Ø32	100	267,00

Height preset h 50 - Analogue with dial gauge Ø 40

Catalogue 8/7

009.644Y



009.644N

009.644

from € 174,00

Code	Body	Plate	Height	Price €
New model with oversized contact - Magnetic				
009.644	Ø62	Ø46	50	174,00
009.644N	Ø62	Ø44	50	183,00
009.644Y	Ø62	Ø44	50	195,00

Tschorn height preset 50mm or 100mm - 50mm version with external dial gauge

New



653.501  
(653.502 magnetic)

653.503  
(653.504 magnetic)

from € 282,00

**T SCHORN®**

Code	Magnet	Plate	Height	Price €
653.501	No	Ø42	100	282,00
653.502	Si	Ø42	100	345,00
653.503	No	Ø47	50	303,00
653.504	Si	Ø47	50	461,00
653.505	Replacement dial gauge h50			104,00



009.645

Code	Body	Plate	Height	Price €
Cannot be used on machine tools with insulated worktop				
009.645	Ø54	Ø14	50	139,00

New

Tschorn height preset - Luminous type - Normal or magnetic version - Test certificate



653.506  
(653.507 magnetic)



Code	Magnet	Plate	Height	Price €
653.506	No	Ø19	60	228,00
653.507	Si	Ø19	60	257,00

009.652  
top view



009.652

Code	Body	Plate	Reading	Price €
009.652	Ø55	Ø25	0,01	134,00



009.651

009.654

Code	Body	Plate	Reading	Price €
009.651	Ø55	Ø25	0,001	159,00
009.654	Ø55	Ø25	0,001	193,00

Haff Schneider



Code	Shank	Total L	Comp.	Price €
<i>Digigraph with double reading - IP67</i>				
975.901	Ø16	134	Ø60	request
<i>Analogue with proportional scale - IP67</i>				
975.501	Ø16	134	Ø60	request
Code	Replacement tips		Price €	
975.511	Standard Ø4 - L31 mm		request	
975.512	Long Ø6 - L56.5 mm		request	

3D Top FH measuring probes - Universal and New Generation models - Tips

Out of catalogue



Code	Shank	Total L	Comp.	Price €
<i>FH Universal model</i>				
975.001	Ø20	163	Ø60	request
<i>FH New Generation model</i>				
975.102	Ø12	126	Ø60	request
Code	Tips for 975.001/101/102		Price €	
975.011	Standard Ø4 - L31mm		request	
975.012	Long Ø8 - L69mm		request	

3D Top FH measuring probes - Zero Master model

Out of catalogue



Code	Shank	Total L	Comp.	Price €
<i>FH Zero Master model</i>				
975.101	Ø10	121	Ø40	request
Spare tips see above - 975.011/012				

Tschorn 3D centering devices - Slimplus V2 Black and 3D Digital model (wireless on request) - Tips

New



TSCHORN®

Code	Shank	Total L	Comp.	Price €
<i>Tschorn 3D Digital model (wireless version on request)</i>				
975.601	Ø12	174	Ø46	request
<i>Tschorn model Slimplus V2 Black</i>				
975.701	Ø12	167	Ø37	request
Code	Replacement tips		Price €	
975.711	Standard Ø3 - L27mm		request	
975.712	Long Ø6 - L62mm		request	



€ 201,00

653.101

Code	Stem	Range	Comp.	Price €
<i>Inside rotation - Dial always visible</i>				
653.101	Ø10	0-300	Ø40	201,00

Out of catalogue

3D Top FH measuring probes - Centro model - Centre tips



Ø16

request

975.001C

Code	Shank	Total L	Comp.	Price €
975.001C	Ø16	192	Ø60	request
Code	Replacement tips			Price €
975.011C	Straight Ø5 mm			request
975.011D	Straight Ø2 mm			request
975.011E	Curved Ø4mm			request

New

Tschorn 3D centering devices - Drehplus V2 Model - Tips



Ø20

request

for lathe

975.715



Code	Shank	Total L	Comp.	Price €
975.715	Ø20	138	Ø37	request
Code	Replacement tips			Price €
975.715P	Conical cap for 975.715			request

○ 975.715 with conical probe tip allows you to measure any cutting insert with various radii and/or angles anywhere on the probe. You tap until both indicators show "0". In this position the contour of the conical tip is exactly on the axis of symmetry

New

Tschorn coaxial centering device - CENTERplus V2 model - Fine adjustment - Screw locking



653.403

172,00

653.402

653.401



Code	Description	Prezzo €
653.401	Ø0-110 coaxial centering device	172,00
653.402	Peacock V2 dial test indicator	233,00
653.403	Arm for Ø200mm	81,00

○ For easy centering of holes and pins  
 ○ For determining the centre of a circle in relation to the spindle with a detection accuracy < 0,010mm  
 ○ Dial test indicator and extension arm not included

Steel swivelling vices - Crank clamping - Bracket arrangement - 0.005/100

Catalogue 8/10



from € 207,00

Code	Opening	Jaw L	Jaw H	Price €
008.470	80	70	30	899,00
008.471	50	50	25	207,00
008.472	75	75	33	251,00
008.473	100	100	38	357,00

Steel vices - Quick clamping - Bracket ready - 0.005/100

Catalogue 8/11

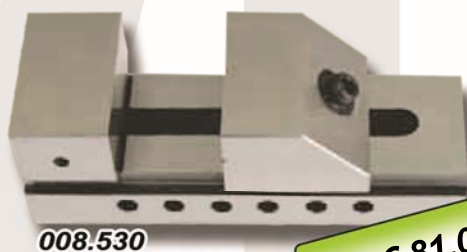

from € 81,00

Code	Total L	Opening	Jaw LxH	Price €
008.529	65	25	25x10	81,00
008.529A	100	40	36x25	87,00
008.530	140	65	50x25	97,00
008.530A	175	85	63x32	119,00
008.531	190	100	73x35	172,00
008.532	245	125	100x45	237,00
008.533	285	160	125x50	347,00
008.533A	330	200	150x50	521,00

Ground steel vices - Bracket ready - 0.005/100

Catalogue 8/11



from € 137,00

Code	Total L	Opening	Jaw LxH	Price €
008.516	155	60	50x25	137,00
008.516A	190	85	63x32	160,00
008.517	210	100	73x35	223,00
008.515	250	128	88x40	307,00
008.518	250	125	100x45	333,00
008.519	300	160	125x50	510,00
008.520	350	210	125x50	569,00

Steel vices - Bracket ready

Catalogue 8/10



from € 34,00

Code	Opening	Jaw L	Jaw H	Price €
008.492	88	100	30	43,00
008.493	120	125	35	71,00
008.495	75	75	35	34,00
008.496	100	100	40	39,00





008.714

from € 129,00

Code	Pairs	Lenght	Thick	Price €
008.709	9	100	4	166,00
Width: 10-14-18-22-26-30-34-38-42				
008.710	9	160	4	199,00
008.690E	9	160	4	129,00
Width: 10-14-18-22-26-30-34-38-42				
008.714	14	150	10	285,00
Width: 14-16-18-20-22-24-26-28-30-32-35-40-45-50				



008.714HQ

from € 199,00

Code	Pairs	Lenght	Thick	Price €
008.710HQ	9	160	4	199,00
Width: 10-14-18-22-26-30-34-38-42				
008.712HQ	12	120	10	299,00
Width: 14-16-18-20-22-24-26-28-30-32-35-40				
008.714HQ	14	150	10	349,00
Width: 14-16-18-20-22-24-26-28-30-32-35-40-45-50				



008.541

from € 229,00

Code	Standard	Price €
DIN 2080 - DIN 69871 - MAS 403 BT		
008.540	ISO 30	233,00
008.541	ISO 40	229,00
008.542	ISO 50	289,00
HSK - PSC 26623-1 - Capto - KM		
008.546	HSK 63 A-B-C-D-E-F	277,00



008.544

€ 89,00

Code	Standard	Price €
DIN 2080 - DIN 69871 - MAS 403 BT		
008.544	ISO 40	89,00





Code	Dimensions	T-slots	Price €
008.621	Ø75 x h45	4 x 8mm	137,00
008.622	Ø100 x h55	4 x 8mm	186,00
008.623	Ø150 x h80	4 x 10mm	319,00
008.624	Ø200 x h108	4 x 13mm	567,00



Code	Dimensions	T-slots	Price €
008.631	Ø75 x h56	4 x 8mm	153,00
008.632	Ø100 x h66	4 x 8mm	269,00



Code	Description	Price €
008.661	Adjustment 89-110 for tables Ø100	93,00
008.662	43-80 adjust. incl. for tables Ø 75	108,00
008.663	Adjustment 93-125 for tables Ø100	99,00



Code	Diam.	Table	Holes	Thread	Price €
008.641	Ø55	Ø75	2	M12	8,00
008.642	Ø55	Ø75	2	M14	8,00
008.643	Ø80	Ø100	4	M12	8,00
008.644	Ø80	Ø100	4	M14	8,00

Code	Diam.	Tables	Collets	Price €
008.651	Ø80	Ø75 e 100	ER16	48,00
008.652	Ø80	Ø75 e 100	ER25	48,00
008.653	Ø80	Ø75 e 100	ER32	57,00

Sizes up to Ø 250 on request



**Not be coupled**

Code	Dimensions	T-slots	Price €
008.526N	125x100x80	3 x T10	156,00
008.527N	175x125x95	3 x T12	212,00
008.528N	250x175x125	3 x T12	303,00
008.529N	380x250x170	3 x T12	489,00

**New**

Concentricity test benches - 008.930 linear guide - 008.940 double station



- o Compact structure o Maximum stability and precision
- o Roller hardness 60 HRC o 008.930 new linear guide system for dial gauge sliding o 008.930 double roller station to increase the measuring range
- o 008.930 range 1-30 mm o 008.940 range 1-90mm
- o Accuracy 0,002 mm o Linearity < 0,01 mm
- o Piece clamping with upper roller
- o Touch test probe non included

Code	Range	Accuracy	HRC Roll	Price €
008.930	1:30	0,002	60	1899,00
008.940	1:90	0,002	60	2649,00



Max. workpiece weight on tailstocks 100 kg

Code	Center	Tips h	Bench	Price €
008.908	300	100	730	795,00
008.909	500	170	930	1121,00
008.910	1000	170	1460	1590,00
008.911	1500	170	1960	2380,00



Code	Max. Ø	Spirals	Max.mm	Price €
008.920	150mm	2-10	500mm	2799,00



**Not be coupled**

Code	Dimensions	T-slots	Price €
008.536	125x100x22	2 x 8mm	187,00
008.537	200x150x28	3 x 10mm	411,00
008.538	250x200x40	3 x 12mm	512,00



Code	Dim.	T-slots	Travel	Price €
008.675	125x100	3x16mm	100mm	141,00

Code	Dim.	T-slots	Travel	Price €
008.685	90x50	9mm	70mm	93,00



Code	Dim.	T-slots	Travel	Price €
008.680	125x100	3x16mm	100mm	196,00



Code	Jaws	Opening	For tables	Price €
008.485	70x20	28mm	$\varnothing 75$	35,00
008.486	80x20	40mm	$\varnothing 100$	43,00

Code	Length	Depth	Opening	Price €
008.690	45	35	30mm	35,00
008.480	50	18	50mm	47,00



Jaws on request

Code	Base	Height	Ø	Price €
008.670	145x145	80	80	286,00



Code	Dimensions	T-slots	Price €
008.521	185x100x104	3x10mm	199,00



Jaws on request

Code	Dimensions	Jaws	Price €
008.600A	80mm	3+3	142,00
008.600	100mm	3+3	152,00
008.601	160mm	3+3	219,00
008.602	200mm	3+3	295,00
008.603	250mm	3+3	348,00



Jaws on request

Code	Dimensions	Jaws	Price €
008.610	100mm	4+4	217,00
008.611	160mm	4+4	239,00
008.612	200mm	4+4	272,00
008.613	250mm	4+4	336,00



Code	Dimensions	V dimen.	Price €
504.201	50x25x32	25	34,00
504.202	75x32x60	44	53,00
504.203	100x41x65	50	65,00
504.204	125x50x80	50	82,00
504.205	150x63x90	82	137,00

from € 34,00

504.203



Code	Dimensions	4 V dimen.	Price €
508.201	95x35x70	20x30x40x50	92,00
508.202	100x30x100	20x30x40x50	129,00
508.203	120x35x120	30x40x50x60	174,00
508.204	120x60x120	30x40x50x60	206,00
508.205	150x75x150	40x50x60x70	261,00
508.206	200x100x200	50x60x70x80	484,00

from € 92,00

508.204



Code	Dimensions	V dimen.	Price €
505.401	75x40x30	5-40	93,00
505.402	100x47x40	5-55	118,00
505.403	150x55x45	5-60	198,00
505.404	200x65x55	5-75	285,00

from € 93,00

505.401



Code	Dimensions	Shanks	Price €
529.501	63x63x50	Ø5-41	176,00
529.501S	Individual V-block as above		96,00
529.502	100x75x75	Ø5-57	362,00
529.502S	Individual V-block as above		200,00

from € 96,00

529.501

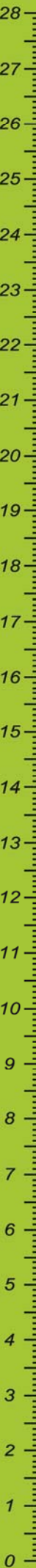



Code	Dimensions	Shanks	Price €
529.303	70x63x45	Ø5-38	172,00
529.304	125x88x70	Ø5-54	440,00



Code	Dimensions	V width	Price €
527.104	70x54x73	38/19	232,00
527.104S	Prism ditto individual		125,00
527.105	100x70x95	50/19	310,00
527.105S	Prism ditto individual		166,00
527.106	150x75x95	55/25	699,00
527.106S	Prism ditto individual		376,00



Code	Dimensions	Slots	Price €
350.501	90x80x65	15	48,00
350.502	115x90x75	15	66,00
350.503	150x125x115	15	93,00
350.504	200x150x125	17	172,00
350.505	300x225x200	25	355,00



Code	Dimensions	Slots	Price €
350.601	90x75x63	15	50,00
350.602	115x90x75	15	72,00
350.603	150x125x115	15	102,00
350.604	200x150x125	17	180,00
350.605	300x225x200	25	399,00



from € 119,00

€ 9,00



670.030

Code	Items	Measures	Price €
670.030	30	Ø3 x 45mm	9,00

Code	Pitch M	Thread	Price €
339.101	80(+20)-Ø12	Ø5 - L20	119,00
339.102	80(+20)-Ø16	Ø5 - L20	129,00

Radius and pitch gauges - All steel - Milled spokes and teeth



from € 6,00

Code	Pc.	Thread/Range	€
409.111	28	Whitworth 55° pitch 62-4 6	6,00
409.112	24	Metric 60° pitch 0.25-6.0 7	7,00
409.113	52	Ww 62-4 - M 0.25-6.0	7,00
409.114	58	Ww 62-4 - M 0.25-6.0- Gas 28-8	7,00

417.101	34	(Blades 17 ins. and 17 out.) 1-7	8,00
417.102	32	(Blades 16 ins. and 16 out.) 7.5-15	12,00
417.103	30	(Blades 15 ins. and 15 out.) 15.5-25	12,00

Thickness gauge with taper blades - Stainless steel - Length 100x12.7

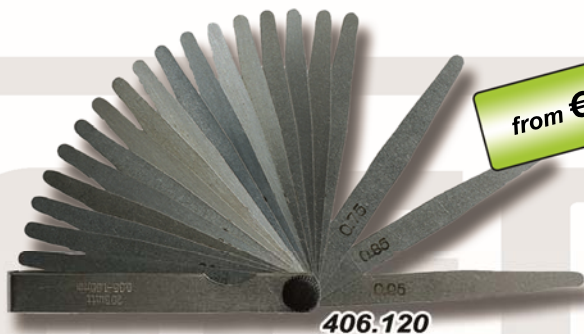

from € 4,00

Code	Blades	Measures	Price €
406.113	13	0,05-1,00	4,00
406.120	20	0,05-1,00	6,00
406.132	32	0,03-1,00	8,00

Rolls of calibrated tape - Hardened steel - Plastic casing



Code	Thickness	Lenght	Price €
742.142	0,02	5mt	29,00
742.143	0,03	5mt	14,00
742.145	0,05	5mt	12,00
742.150	0,10	5mt	12,00
742.153	0,15	5mt	12,00
742.156	0,20	5mt	12,00
742.157	0,25	5mt	12,00
742.158	0,30	5mt	12,00
742.160	0,40	5mt	12,00
742.162	0,50	5mt	13,00



697.901A

**\*Transport costs not included in the price**

Code	Dimensions	Weight	*Price €
697.900A	300x200x50	9Kg	89,00
697.901A	400x250x60	18Kg	129,00
697.902A	500x315x70	33Kg	199,00
697.903A	630x400x80	60Kg	259,00
697.904A	800x500x100	120Kg	489,00
697.905A	1000x630x140	260Kg	629,00
697.906A	1200x800x160	460Kg	1229,00
697.907A	1600x1000x180	860Kg	1799,00
697.908A	2000x1000x200	1280Kg	2599,00



698.903

Code	For plates	Dimensions	Price €
698.903	630x400	530x350	329,00
698.904	800x500	700x400	369,00
698.905	1000x630	900x530	399,00
698.906	1200x800	1100x700	459,00
698.907	1600x1000	1400x800	499,00
698.907	2000x1000	1400x800	499,00

Code	Description	Price €
698.901	Set of 4 vibration-damping feet	53,00



682.001N

Code	Dimensions	Weight	Price €
682.001N	500x50x80	5Kg	239,00
682.002N	750x50x100	10Kg	348,00
682.003N	1000x60x140	23Kg	631,00
682.004N	1500x80x180	40Kg	1053,00
682.005N	2000x100x200	80Kg	1612,00



686.204

Grade 0 or 00 squares on request

Code	Dimensions	Weight	Price €
686.201	100x63x16	0,35Kg	105,00
686.202	160x100x20	1Kg	195,00
686.203	250x160x25	2,5Kg	272,00
686.204	400x250x40	8,5Kg	450,00
686.205	630x400x63	30Kg	1121,00
686.207	1000x630x80	101Kg	2753,00

Delivery 5/6 days after order





from € 21,00

Code	Description	Price €
698.991	Spray cleaner 1l	35,00
698.993	Prussian Blue Paste 250ml	28,00
698.994	Prussian Blue Spray 300ml	28,00
698.998	Polishing wax 1l	25,00
698.998B	Polishing wax 5l	109,00
698.999	Universal cleaner 1l	21,00

Scales - Counting from 3 to 30 kg - Dual display (front and back)

VIDEO INSTRUCTION



879.060

from € 99,00



Code	Capacity	Resol,	Plate	Price €
879.030	3Kg	0,1gr	25x18	109,00
879.060	6Kg	0,2gr	25x18	109,00
879.150	15Kg	1,0gr	25x18	99,00
879.300	30Kg	1,0gr	25x18	119,00

Scales - Platform from 100 to 300 kg - Folding rod



from € 99,00

879.410

Code	Capacity	Resol,	Plate	Price €
879.410	100Kg	20gr	30x40	99,00
879.415	150Kg	50gr	30x40	99,00
879.430	300Kg	50gr	45x60	159,00

Class F1 weights in steel - Set of weights 1mg-500gr or single weight of 1Kg

New



006.411

from € 104,00

006.401

Code	Pc.	Range	Class	Price €
006.401	24	1mg-500gr	F1	314,00
006.411	1	1Kg	F1	104,00

Until out of stock

Digital force gauges - Push and pull - 1-500 kg - Stands up to 20 kg max.



€ 209,00

970.690



from € 275,00

970.750



970.602



RS232 + USB

Code	Kg	Resolut.	Accuracy	Price €
970.601	1	1g	0,2%+1d	275,00
970.602	2	1g	0,2%+1d	284,00
970.750	500	10g	0,2%+1d	459,00

Code	Description	Price €
970.690	Stands up to 20 kg	209,00

€ 728,00



970.620

from € 359,00



970.500



970.491

970.490



Micro SD 8 GB

Code	Kg	Resolut.	Accuracy	Price €
970.620	20	10g	0,5%+1d	359,00

Code	Description	Price €
970.490	Stand h500 - Base 250x230	728,00
970.491	Part locking clamp	35,00



RS232 + USB

Code	Kg	Resolut.	Accuracy	Price €
970.405	5	1g	0,4%+1d	408,00
970.500	100	50g	0,5%+1d	551,00

Catalogue 9/8

Crane scales - Dynamometers for lifting weights from 1000 to 5000 kg



879.630

from € 639,00



Remote control

Code	Capacity	Resolut.	Weight	Price €
879.610	1000Kg	500gr	20Kg	639,00
879.630	3000Kg	1000gr	22Kg	799,00
879.650	5000Kg	2000gr	24Kg	859,00



879.900

Code	Carload	Course	Measures	Price €
879.900	100kg	1500mm	900x600	request

**Characteristics:**

- o Completely made in Italy
- o Top quality components
- o CE marking for machine and accessory
- o Usable without licenses and periodic courses by the staff
- o Sealed batteries, no risk of acid or fume leakage

**Because it's a different product:**

- o construction completely internal to the manufacturer
- o lifting with worm screw, no ropes or chains
- o no maintenance or legal checks
- o No risk of accidental crushing due to breakage
- o Anti-tipping device when descending
- o Spare parts ready for delivery
- o Customization of accessories on request and quick changes

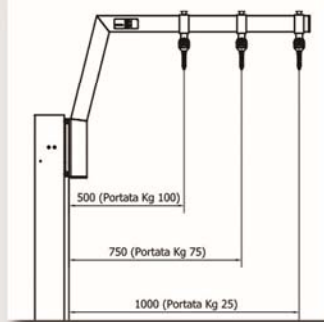

**CRANE ARM WITH MAX CAPACITY OF 100KG INCLUDED IN THE SUPPLY**

for other possible accessories, contact our sales office

**The advantages:**

- o Electric and non-manual lifting
- o 4 swivel wheels and thus movement in confined spaces
- o Lightness of the machine that can be used by everyone
- o Robust construction
- o No statutory periodic checks
- o Telephone support
- o Future configurability
- o Flexibility to change the accessory in seconds



Length	900 mm
Width	600 mm
Height	2050 mm
Ride	1500 mm
Carrying capacity	100 kg
Front wheels	80 mm
Rear wheels with brakes	125 mm
Power supply	24V
Batteries charger	Integrated 220V
Batteries	2 of 10 Ah
Batteries charger cable	Supplied
Machine weight	80 kg
Frame structure	Painted

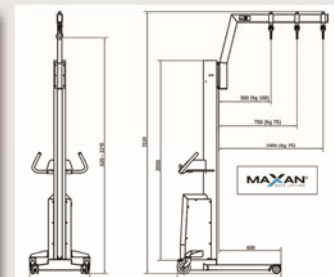

**IDEAL FOR METROLOGICAL ROOMS  
WORKBENCHES AND ASSEMBLY LINES**

**MAXAN**<sup>®</sup>  
SAFE LIFTING

New

Endoscopes with 5" color monitor - Interchangeable probes to be ordered separately



937.601

Code	Probe Ø	Probe L	Pixel	Price €
937.601	5,5mm	1mt	1280x720	199,00
Endoscope with 5" monitor and Ø5,5mm probe				

- o **Monitor:** 5 inches HD ris. 854x480 pixels
- o **Twirling images:** 180°
- o **Video resolution:** 1280x720
- o **Images resolution:** 1920x1080
- o **Doors:** Type-C USB e TF card slot
- o **Camera:** 5,5mm or optional cameras
- o **Resolution:** 1.0 Megapixel HD
- o **Visual angle:** 70°
- o **Light:** 6 variable intensity led



937.602

Code	Probe Ø	Probe L	Pixel	Price €
937.602	3,9mm	1mt	1280x720	249,00
Endoscope with 5" monitor and Ø3,9mm probe				

- o **Monitor:** 5 inches HD ris. 854x480 pixels
- o **Twirling images:** 180°
- o **Video resolution:** 1280x720
- o **Images resolution:** 1920x1080
- o **Doors:** Type-C USB e TF card slot
- o **Camera:** 3,9mm or optional cameras
- o **Resolution:** 1.0 Megapixel HD
- o **Visual angle:** 70°
- o **Light:** 6 variable intensity led



937.651

Code	Probe Ø	Probe L	Attacco	Price €
937.611	5,5mm	1mt	937.601/2	83,00
937.612	5,5mm	3mt	937.601/2	114,00
937.613	3,9mm	1mt	937.601/2	135,00
937.614	3,9mm	3mt	937.601/2	167,00
Interchangeable probes for endoscopes 937.601-937.602				

Code	Probe Ø	Probe L	Pixel	Price €
937.651	5,0mm	5mt	1920x1080	261,00
Endoscope with double chamber for front and side view				

- o **Monitor:** 5 inches HD ris. 1280x720 pixels
- o **Video resolution:** 1280x720 - 1920x1080
- o **Images resolution:** 1920x1080
- o **Doors:** Type-C USB e TF card slot
- o **Camera:** 5,0mm
- o **Resolution:** 1.0 Megapixel HD
- o **Visual angle:** 70°
- o **Light:** 4 variable intensity led

Endoscopes with 3.5" colour monitor - Probes to be ordered separately

Until out of stock



Code	Pixel	Zoom	Angle	Price €
Detachable monitor - Probes to be ordered separately				
937.172	320x240	1x - 4x	12,7-305	226,00

Code	Pixel	Lenght	Diam.	Price €
Probes for endoscopes 937.171-172 - 60° angle				
937.173	640x480	1000	Ø5,5	132,00
937.174	640x480	3000	Ø5,5	152,00
937.175	640x480	1000	Ø9	59,00
937.176	640x480	3000	Ø9	102,00
937.177	640x480	1000	Ø12	48,00
937.178	640x480	3000	Ø12	76,00



Code	Lenght	Diam.	Angle	Price €
Extensions for probes 973.173/178 - Ø 18 - 60° angle				
937.185	1000	Ø18	60°	14,00
937.186	2000	Ø18	60°	21,00
937.187	3000	Ø18	60°	33,00
937.188	4000	Ø18	60°	45,00

Code	Diam.	Details	Price €
Set of accessories for probes (*1 Protection sheath - *2 Magnetic *3 and *5 90° mirror - *4 Hook - *6 Magnetic hook)			
937.161	Ø5,5	1 - 2 - 3	15,00
937.162	Ø9	1 - 2 - 3 - 4	15,00
937.163	Ø12	4 - 5 - 6	15,00

Endoscopes with 5" colour monitor - Probes to be ordered separately

Catalogue 9/5



Code	Pixel	Zoom	Angle	Price €
Detachable monitor - Probes to be ordered separately				
937.191	800x480	1x - 4x	12,7-305	308,00

Code	Pixel	Lenght	Diam.	Price €
Probes for endoscopes 937.191 - 60° angle				
937.195	640x480	1000	Ø9	65,00
937.196	640x480	3000	Ø9	87,00
937.197	640x480	1000	Ø12	50,00
937.198	640x480	3000	Ø12	76,00

Endoscopes without LCD - Wi-Fi for smartphones - Probe included, Ø 9 x L 1000

Out of catalogue



Downloadable App free of charge

Code	Pixel	Zoom	Angle	Price €
Special for smartphones - Probe Ø 9 x L 1000 included				
937.181	640x480	V.Handy	60°	102,00



906.501

Code	Description	Price €
Hardness testers with analogue display		
906.501	Manual	1929,00
906.509	Motorised	1999,00



906.509 (motorised)

from € 1929,00

Code	Description	Price €
Hardness testers with digital display		
906.505	Manual	1999,00



€ 1999,00

906.505



€ 4214,00

906.901

Preload 10 kgf - 98.07 N  
Loads 60 kgf - 100 kgf - 150 kgf

2 HRC test blocks 1 HRB test block  
1 diamond indenter 120° + 1 ball indenter Ø 1.5875  
2 round plates Ø 55 and Ø 150 + 1 prismatic plate

HRA 20:88 - HRB 20:100 - HRC 20:70 - HRD 40:70  
HRF 60:100 - HRG 30:94 - HRH 80:100 - HRK 40:100

Code	Description	Price €
Digital and motorised hardness testers - Automatic memory		
906.901	Printer included	4214,00



€ 599,00

€ 97,00

901.130

901.199

VIDEO INSTRUCTION



Code	Parameters	Accur.	Price €
Supplied with USB charger, brush, lanyard and case			
901.130	HL-HRC-HRB-HV-HB-HS...	±0,5%	599,00
901.199	Calibration test block for hardness tester		97,00

Digital hardness testers - Shore A - D - C and Rubber test blocks for hardness testers - 10 pcs Shore

Catalogue 9/14



from € 126,00

Code	Range	Accuracy	Reading	Price €
Shore A for soft rubber				
009.620	0:100 HA	2%	0,5 HA	126,00
Shore D for hard rubber and plastics				
009.621	0:100 HD	2%	0,5 HD	126,00
Shore C for foam and sponge				
009.622	0:100 HC	2%	0,5 HC	130,00

Tip Ø1.25x L2.5 chamfered 35° Ø 0.79 penetrating  
 Tip Ø 2.5 x L 2.5 spherical SR 5.5 penetrating  
 Tip Ø 1.25 x L 2.5 chamfered 30° SR 0.1 penetrating

Code	Nominal hardness	Price €
7 coloured test blocks Shore A		
009.600	34 - 40 - 55 - 67 - 78 - 85 - 91	152,00
3 coloured test blocks Shore D		
009.601	28 - 42 - 83	101,00

Portable hardness testers - New software included - Interchangeable D probe - Test block included

Catalogue 9/8



€ 1199,00

Code	Parameters	Accur.	Price €
901.910	HL-HRC-HRB-HV-HB-HS	±0,5%	1199,00

New software and USB socket - 600-group memory

Portable hardness testers with printer - New software - Interchangeable probe D - Test block included

Out of catalogue



€ 1199,00

Code	Parameters	Accur.	Price €
901.160	HRC-HRB-HV-HB-HS-HRA-HSD	±0,5%	1199,00

Including software and USB socket

Portable hardness testers - Interchangeable D probe - Test block included

Catalogue 9/8



€ 699,00

VIDEO INSTRUCTION



Code	Parameters	Accur.	Price €
901.150	HL-HRC-HRB-HV-HB	±6HLD	699,00

100-group memory - Min. thickness 5 mm



€ 1099,00

935.110



VIDEO INSTRUCTION



Code	Ra $\mu\text{m}$ - Rz $\mu\text{m}$	Sampling	Price €
935.110	0,05:10 - 0,1:50	0,25-0,8-2,5	1099,00

Accuracy 0.01  $\mu\text{m}$  - Repeatability < 12%  
4 parameters Ra, Rz, Rq, Rt  
Rating L 0.25 and 4 mm - Speed 1 mm/sec



€ 1899,00

935.210

000 \* 01:26  
Ra 1.555  $\mu\text{m}$   
LTH: 0.8\*5mm STD: ISO  
RAN:  $\pm 40\mu\text{m}$  FIL: RC

Display



Sonda



Code	Ra $\mu\text{m}$ - Rz $\mu\text{m}$	Sampling	Price €
935.210	0,005:16 - 0,02:160	0,25-0,8-2,5	1899,00

Accuracy <  $\pm 10\%$  - Repeatability < 6%  
Ra 0.005 - Rz 0.02 + 11 other parameters  
Rating L1 and 4 mm



935.905

€ 243,00



935.901

€ 1508,00

Roughness tester with 2 parameters (Ra-Rz)

Code	Ra $\mu\text{m}$ - Rz $\mu\text{m}$	Sampling	Price €
935.901	0,05:10 - 0,005:100	0,25-0,8-2,5	1508,00



935.902

€ 1863,00

Roughness tester with 4 parameters (Ra-Rz-Rq-Rt)

Code	Ra $\mu\text{m}$ - Rz $\mu\text{m}$	Sampling	Price €
935.902	0,005:16 - 0,02:160	0,25-0,8-2,5	1863,00

Code	Description	Price €
935.905	Roughness tester stand	243,00







935.462

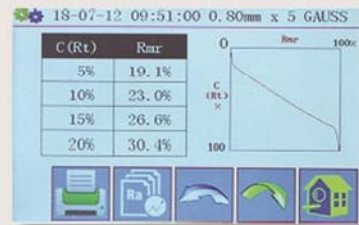

Axes



App



Parameters



Probe extracted

Code	Range	Sampling	Price €
935.462	160 $\mu\text{m}$ (-80/+80 $\mu\text{m}$ )	0,25-0,8-2,5	2378,00

Accuracy  $\pm 7\%$  - Repeatability  $< 6\%$  - Parameters Ra, Rz, Rq, Rt, Rp, Rv, R3z, R3y, Rz(JIS), Rs, Rsk, Rsm, Rku, Rmr, Ry, Rmax, Rc - Speed from 0,135 a 1mm/sec



945.930



New software + USB socket + 1 straight and 1 angle probe

Code	Range	Speed	Error	Price €
945.930	0,75:350	1000:9999	$\pm(0,5\%+0,01)$	746,00

Memory 2000 measurements  
Built-in reset plate

New

Ultrasonic thickness testers



945.201

Code	Range	Speed	Error	Price €
945.201	0,75:225	1000:9999	$\pm(0,5\%+0,1)$	474,00

Resolution 0,001mm or 0,1mm  
Error 1:10mm  $\pm 0,05\text{mm}$

Analog multimeters and analog multimeter testers - Various functions - Large display

New



€ 39,00

985.300

Code	Description	Price €
985.300	Analog multimeters	39,00

- Voltage AC (VAC) without components DC
- Voltage DC (VDC) without components AC
- Voltage DC (IDC) without components AC
- Resistance ○ Continuity test buzzer ○ Test LED diodes
- Decibel (dB)
- Supply: 2 batteries 1,5V AA + 1 battery 9V



€ 119,00

985.310

Code	Description	Price €
985.310	Analog multimeters tester	119,00

- Sensitivity 20kΩ/Vcc - 4kΩ/Vca
- Voltage CC 100mV-2V-10V-50V-200V-500V-1000V (± 2%)
- Voltage CA 10V-50V-250V-750V (± 2%)
- Voltage CC 50μA-500μA-5mA-50mA-500mA-5A (± 2%)
- Voltage CA 250μA-2,5mA-25mA-250mA-2,5A (± 2%)
- Resistance Ωx1-Ωx10-Ωx100-Ωx1000 (± 2%) range from 0 to 10MΩ
- Capacity 22μf-220μf-2200μf-22000μf ballistic measurement
- Diode test, transistor test, continuity test, LED test, 1,5-9V battery test
- Galvanometer protections with silicon diodes, measurements in Ω with fuse and varistors
- Supply: battery 9V type 6F22

Digital clamp meters - TRMS or No TRMS models

New



985.400

from € 79,00

985.410

Code	Description	Price €
985.400	Digital clamp meters TRMS	79,00
985.410	Digital clamp meters no TRMS	99,00

- 4000count LC-type backlit display and bar graph
- Wide measurement range from 0.01A AC/DC to 1000A AC/DC
- Measurement of AC and DC voltages up to 600V
- Measurement of capacitance values up to 40mF
- Temperature measurement from -40° to +1000°C
- Auto shut-off after about 20 minutes of inactivity

Colorimeter for surface color differences - Digital display - Measurements according to CIE LAB

New



€ 399,00

946.540



Code	Area	Angle	Time	Price €
946.540	8mm	10°	1,5sec	399,00

- Chromatic spaces: CIE LAB, CIE XYZ, RGB, CMYK, Pantone
- Sensor wavelength: 400...720nm
- Measurement area: 8mm ○ Measurement angle: 10° CIE str.
- Measurement time: 1,5 sec. ○ Lighting: White LED
- Lightning angle: 45° ○ Sensor: Photodiode RGB
- Interface: Micro USB
- Supply: Battery 3,7V ○ USB



Code	Optical	Contact	Speed	Price €
947.501	5:99999	0,5:19999	0,05:1999	242,00
947.501E	5:99999	0,5:19999	0,05:1999	92,00



Resolution 0.1 RPM < 1000 RPM (over 1 RPM)  
 Meter counter resolution 0.01 m/min < 100 m/min (over 0.1)  
 Accuracy ± (0.05% + 1 digit)

Code	Optical	Contact	Speed	Price €
947.601	10:99999	0,5:19999	0,05:1999	299,00



All models are supplied with memory:  
 Min/max value - Last value  
 Memory capacity 96 data items

Code	RPM Optical	Accuracy	Price €
947.601E	2,5:99999	±0,05%+1d	76,00
Resolution 0.1 RPM (2.5-999.9) over 1 RPM			

Code	RPM Contact	Accuracy	Price €
947.602E	0,5:19999	±0,05%+1d	80,00
Resolution 0.1 RPM (0.5-999.9) over 1 RPM			
Surface speed 0.05-1,999.9			

Code	RPM Contact	Accuracy	Price €
947.603E	0,5:19999	±0,05%+1d	122,00
Resolution 0.1 RPM (2.5-999.9) over 1 RPM			



€ 314,00

946.501

€ 109,00



946.505

Ellipse, long axis 8, short axis 4 - 100-group memory

Code	Gloss	Resolut.	Error	Price €
946.501	200 GU	0,1 GU	1 GU	314,00
946.505	Thermal printer			114,00



€ 1212,00

946.511



Gloss	Gloss	Gloss
2000	1000	160
Angle 20°	Angle 60°	Angle 85°
Ellipse 10x10	Ellipse 9x15	Ellipse 5x38
Resolution 1,0GU	Resolution 0,1GU	Resolution 0,1GU

Code	Gloss	Resolut.	Error	Price €
20-60-85° instruments for paint and glossy metals				
946.531	2000 GU	0,1 GU	1 GU	1212,00



980.601



RS232 + USB



Micro SD 8 GB

€ 399,00

Code	Capacity dB	Hz	Price €
980.601	30:80-50:100-80:130	31,5:16000	399,00

Accuracy A (human ear) and C (machine noise)

KHz	0,03	0,06	0,12	0,25	0,5	1	2	4	8
db±	2	1,5	1,5	1,4	1,4	1,1	1,6	1,6	2,1

Class I



€ 84,00

982.415

Capacity 35-130dB A/C accuracy  
Accuracy ±2dB

Code	Capacity dB	Hz	Prezzo €
982.415	30:70-60:100-90:130	125-8000	84,00



963.001 da € 9,00

Code	Probe	Range	Price €
K probes for thermometers 963-964-965			
963.001	Flush	-40:250°C	9,00
963.002	Standard	-50:900°C	82,00
963.003	High temp.	-50:1200°C	124,00
963.004	Surface	-50:400°C	161,00



€ 194,00

Code	Range	Accuracy	Price €
Dual input thermometer for K probes only			
963.916	-50:1230°C	±1%+1°C	194,00



€ 265,00

Code	Range	Accuracy	Price €
Dual input thermometer for 100 Ohm Pt or K probes			
964.917	-100:1370°C	±0,1% o 0,2°C	265,00
964.100	Probe 100Ohm x 964 - 50:400°C		164,00



RS232 + USB

964.917 and 965.901 can also use the K probes slightly losing accuracy



€ 239,00

Code	Range	Accuracy	Price €
Thermometer with 4 inputs for 100 Ohm Pt or K probes			
965.901	-250:1370°C	±0,5%	239,00
964.101	Probe 100Ohm x 965 - 50:400°C		164,00



Micro SD 8 GB



RS232 + USB

963.901E



from € 7,00

963.902E



963.903E



963.904E



Code	Range	Accuracy	Price €
963.900E	-50:1300°C	±0,3%-2°C	79,00

Code	Probe	Range	Price €
K probes for thermometers 963.900E			
963.901E	Flush	-40:200°C	7,00
963.902E	Standard L80	-50:400°C	18,00
963.903E	Standard L150	-50:400°C	18,00
*963.904E	Surface	-50:400°C	60,00



€ 79,00

963.900E

Infrared thermometers for body temperature - Audible alarm - Backlighting

Out of catalogue



€ 39,00

960.100

**IT IS NOT  
MEDICAL  
DEVICE**

Code	Range	Accuracy	Resolut.	Price €
960.100	32:42,5°C	0,3°C	0,1°C	39,00

Digital thermometers - Infrared rays - Laser beam

Out of catalogue



da € 68,00

960.520E

960.350E

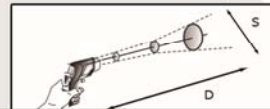

Indicates the  $\varnothing$  of the measured surface S in relation to the distance D

Code	Range°C	D:S	Accuracy	Price €
Economic model with infrared rays and laser beam				
960.350E	-25:400	10:1	$\pm 2\% + 1^\circ\text{C}$	68,00
Laser beam - Resolution 1°C - Hold function				

Code	Range°C	D:S	Accuracy	Price €
Economic model with infrared rays and laser beam				
960.520E	-30:520	10:1	$\pm 1,5\% + 1^\circ$	84,00
Laser beam - Resolution 0.5°C - Hold function				

Digital thermometers - Infrared rays - Laser beam

Catalogue 9/22



€ 269,00

RS232

960.101

€ 122,00

960.301

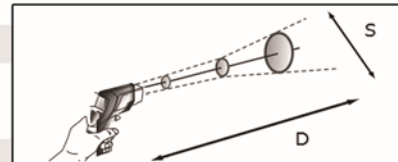

Indicates the  $\varnothing$  of the measured surface S in relation to the distance D

Code	Range°C	D:S	Accuracy	Price €
Average model with K probe input (-50:1230°C)				
960.101	-20:400	7:1	$\pm 3\%$	269,00

Laser beam - Min/max memory - Hold function

Code	Range°C	D:S	Accuracy	Price €
Top of the range model with K probe input				
960.201	-30:1000	50:1	$\pm 2\%$	341,00

Two laser beams - Min/max memory - Hold function

Code	Range°C	D:S	Accuracy	Price €
Smaller model				
960.301	-30:305	7:1	$\pm 3\%$	122,00

Laser beam



€ 341,00

960.201



€ 2471,00

945.510

Software and USB socket  
1 straight probe + 1 angle probe  
Automatic calibration on specimens  
High sampling rate with low noise

Code	Range	m/sec	Prec.	MHz	Price €
945.510	0:6000	>11000	≤3%	0,4:15	2471,00

Resolution 0.1 mm (2.5:100 mm, over 1 mm)  
Horizontal linear error ≤ 0.1%  
Speed of sound 1000 m/s: 15000 m/s  
Memory 980 scans



€ 214,00

955.502

Field testers with external 3-axes probe

Code	P.mGauss	P.µTesla	Price €
955.502	200:20000	20-2000	214,00

VIDEO INSTRUCTION



€ 699,00

915.920



New software and USB socket - 1560-group memory

Code	Substr.	µm	Accuracy	Price €
915.920	Ferrous	0:1250	±2%+1	699,00
915.921	Non ferr.	0:1250	±2%+1	699,00
Code	Interchangeable probes			Price €
915.928	Spare/add. probe Fe			171,00
915.929	Spare/add. probe NFe			171,00



€ 362,00

915.205

Minimum area Ø 10 mm  
Curvature: convex 5 - concave 20  
Including 2 Fe and NFe specimens + 5 shims  
Resolution 0.1 µm

Code	µm	Accuracy	Price €
915.205	0:1250	±(1:3%)+1	362,00



Analog and digital torque wrenches - Easy adjustment - (530.105 digital version)

New



530.101

from € 69,00

Code	Range	Connect.	Lenght	Price €	
530.101	5:25	1/4"	230mm	69,00	
530.102	20:220	1/2"	485mm	89,00	
530.103	40:400	1/2"	665mm	119,00	
530.104	100:500	3/4"	665mm	129,00	
Digital version	530.105	3:30	3/8"	230mm	169,00

Light meters - SD card - K probe input for temperature measurements

Catalogue 9/19



€ 165,00



967.701



RS232 + USB



Micro SD 8 GB

Resolution lux 1 (2000) - 10 (20000) - 100 (100000)  
Temperatures with K probes -50:1300°C

Code	Lux measuring ranges	Accuracy	Price €
967.701	2000-20000-100000	±4%+dig	165,00

Universal instrument 5 in 1 - Sound level - Hygrometer - Anemometer - Light meter - Thermometer

Catalogue 9/17



€ 123,00

966.501



RS232 + USB

Code	Measurement	Prezzo €
966.501	Fono-Igro-Anemo-Lux-Termo	123,00

Temperature con sonda K (esclusa) -50:1300°C

Sound level meter 35:130 dB (Class II)  
Hygrometer 10:95% and temperature 0:50°C  
Light meter 0:20000 lux  
Anemometer 0.4:30 m/s - 1.4:108 km/h

Oxygen gas detector (O2) - Carbon monoxide (CO) and density detector - Gas leak detector

New



985.200

985.201

985.203

from € 149,00

Code	Measur. range	Resolution	Price €
985.200	0:1000ppm	1ppm	149,00

Error < ± 5% Response time < 30 sec  
Detection of toxic or harmful gases

985.201	0:25%(vol)	0,1%(vol)	227,00
---------	------------	-----------	--------

Error ± 0.5% Applications and uses in workplaces, vehicles...  
O2 measurements in minerals - O2 density at high altitudes

985.203	0:10.000ppm	1ppm-0,1%	172,00
---------	-------------	-----------	--------

Error ± 2% - Response time < 3 s  
Temperature -5°C/50°C - Humidity < 90% RH

New

Vision Engineering bench lenses - High quality - LED lights - Spring balance



from € 279,00

996.960

996.950

- 996.960 The glass lens with a diameter of 127mm is equipped with circular LED lighting. This is a perfect way to light up an object without shadows
- 996.950 Rectangular 171x114mm glass lens offers shadow-free magnification and 3D viewing with dimming left and right illumination
- The 3D function is useful for rework and inspection of electronic boards or other delicate components
- The innovative spring system ensures perfect positioning with no knobs to tighten
- For both models glass lenses of 5 diopters
- Vision Engineering's bench magnifiers incorporate the same excellence adopted for its microscopes ensuring maximum clarity

Vision  
ENGINEERING

Codice	Lens	Diopters	Light	Price €
996.960	Ø127	5	Circular	279,00
996.950	171x114	5	Sx e Dx	539,00

New

Videomicroscope with quick autofocus - Without monitor - Manual measurement possible



936.201

€ 2699,00



3 type of lightning



Monitors not included

Lights	Episcopic+Diascopic+Coaxial
Monitor magnification (1-6X)	Min. 29,92-179,5X - Max. 192,34-1.154X
Lens magnification	0,7-4,5X
Optical resolution	Min. <8,77 µm - Max. <3,94 µm
Focal distance	88 +/-2 mm
Field of view FOV (D*H*V) mm	Min. 18,3*15,9*8,95 - Max. 2,84*2,47*1,39
Sensor camera - resolution	CMOS Color - 2MP
Data out / Video out	USB / HDMI
Max height piece	50 mm
Dimensions	320x308,5x417,5 mm
Color monitor	Not included

Codice	Description	Prezzo €
936.201	Videomicroscope	2699,00



996.802

€ 118,00



996.802 90 Led

Code	Lens Ø	Light	Watt	Price €
996.802	127	90 Led	7W	118,00
Fixed lens of 5 dioptries				



996.804

€ 37,00



€ 90,00

Code	Description	Price €
996.803	Stand with 4 swivel wheels	33,00
996.804	Round table stand	37,00



Interchangeable lens

996.902

Code	Lens Ø	Light	Watt	Price €
996.902	127	60 Led	12W	90,00
Fixed lens of 8 dioptries				
996.906	Replacement lens for 996.901/2			19,00



€ 33,00

from € 111,00

996.803

996.903-904

Code	Lens Ø	Light	Watt	Price €
996.903	127	60 Led	12W	111,00
996.904	150	60 Led	12W	137,00
2 interchangeable lenses of 3+20 and 5+20 dioptries				
Version including dimmer switch for article 996.904 only				

€ 12,00



996.905

Code	Lens Ø	Light	Watt	Price €
996.905	150	---	---	12,00
Interchangeable lens of 8-10-12-15 dioptries - for 996.904 only				



Code	Hight	Body	Watt	Price €
Halogen 24V - 50W				
996.821	110	Ø90	50W	85,00
996.820	650	Ø90	50W	173,00

Codice	Hight	Body	Watt	Price €
Halogen 24 V with protection grid - IP54 - 50W				
996.811	110	Ø125	50W	108,00
996.810	890	Ø125	50W	179,00



Codice	Hight	Body	Watt	Price €
LED 24 V - IP54 - 8W				
996.831	110	Ø125	8W	229,00
996.830	890	Ø125	8W	292,00

# **PROMO 2023**

## **ACCREDIA CERTIFICATIONS AD CALIBRATION**



Previously



**Some imported articles can be alternatively supplied with German or English certificates having the same validity.**



Precedentemente

**DKD**



### **Average delivery time 10/15 days**

**The certificates are registered in the name of Vogel S.r.l.  
At the time of ordering, you can provide us with the details  
of the end user.**

**A fee of € 36.00 will be charged for a subsequent modification.**

**Prices include return transport from our company to the laboratory.  
Transport costs from the toolmaker to our company and vice versa are not included.**

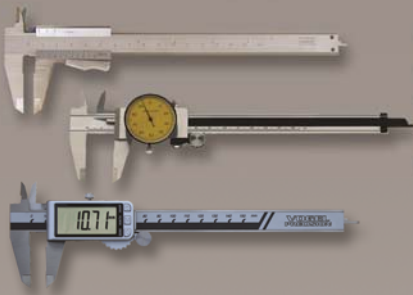

C001.150	ACCREDIA <small>UNIVERSITÀ ITALIANA DI ACCREDITAMENTO</small>	Vernier/counter/digital calipers up to 150	104,00
C001.200	ACCREDIA <small>UNIVERSITÀ ITALIANA DI ACCREDITAMENTO</small>	Vernier/counter/digital calipers 150 up to 200	106,00
C001.300	ACCREDIA <small>UNIVERSITÀ ITALIANA DI ACCREDITAMENTO</small>	Vernier/counter/digital calipers 200 up to 300	133,00
R001.150	Calib. Rep.	Vernier/counter/digital calipers up to 150	36,00
R001.200	Calib. Rep.	Vernier/counter/digital calipers 150 up to 200	38,00
R001.300	Calib. Rep.	Vernier/counter/digital calipers 200 up to 300	58,00



C001.500	ACCREDIA <small>UNIVERSITÀ ITALIANA DI ACCREDITAMENTO</small>	Vernier/digital calipers 300 up to 500	144,00
C001.1000	ACCREDIA <small>UNIVERSITÀ ITALIANA DI ACCREDITAMENTO</small>	Vernier/digital calipers 500 up to 1000	298,00
R001.500	Calib. Rep.	Vernier/digital calipers 300 up to 500	104,00
R001.800	Calib. Rep.	Vernier/digital calipers 500 up to 800	137,00
R001.1000	Calib. Rep.	Vernier/digital calipers 800 up to 1000	152,00
R001.3000	Calib. Rep.	Vernier/digital calipers 1000 up to 3000	request



R575.023	Calib. Rep.	Go/No Go plug gauges up to $\varnothing$ 50 each	23,00
R575.503	Calib. Rep.	Go/No Go plug gauges from $\varnothing$ 50 to 75 each	30,00
R575.753	Calib. Rep.	Go/No Go plug gauges from $\varnothing$ 75 to 100 each	40,00
R576.003	Calib. Rep.	Go/No Go plug gauges from $\varnothing$ 100 to 150 each	47,00
R576.503	Calib. Rep.	Go/No Go plug gauges from $\varnothing$ 150 to 200 each	59,00
R577.003	Calib. Rep.	Go/No Go plug gauges from $\varnothing$ 200 to 250 each	69,00

Intermediate check of  $\varnothing$  3 at 3 different heights (6 measurements in total)



C575.061	ACCREDIA <small>UNIVERSITÀ ITALIANA DI ACCREDITAMENTO</small>	Individual Go/No Go plug gauges	72,00
----------	--	---------------------------------	-------

Complete check of  $\varnothing$  3 at 3 different heights + ovality  $\varnothing$  3 at  $90^\circ$  (total 12)



C569.002	ACCREDIA <small>UNIVERSITÀ ITALIANA DI ACCREDITAMENTO</small>	Thread ring gauges from $\varnothing$ 5 to $\varnothing$ 120 each	91,00
R569.003	Calib. Rep.	Thread ring gauges from $\varnothing$ 3 to $\varnothing$ 20 each	21,00
R569.020	Calib. Rep.	Thread ring gauges from $\varnothing$ 20 to $\varnothing$ 50 each	26,00
R569.050	Calib. Rep.	Thread ring gauges from $\varnothing$ 50 to $\varnothing$ 75 each	34,00
R569.075	Calib. Rep.	Thread ring gauges from $\varnothing$ 75 to $\varnothing$ 150 each	39,00



C572.002	ACCREDIA <small>UNIVERSITÀ ITALIANA DI ACCREDITAMENTO</small>	Thread Go/No Go plug gauges from $\varnothing$ 5 to $\varnothing$ 120 each	91,00
R572.003	Calib. Rep.	Thread Go/No Go plug gauges from $\varnothing$ 3 to $\varnothing$ 20 each	29,00
R572.020	Calib. Rep.	Thread Go/No Go plug gauges from $\varnothing$ 20 to $\varnothing$ 50 each	34,00
R572.050	Calib. Rep.	Thread Go/No Go plug gauges from $\varnothing$ 50 to $\varnothing$ 75 each	39,00
R572.075	Calib. Rep.	Thread Go/No Go plug gauges from $\varnothing$ 75 to $\varnothing$ 150 each	46,00



C009.648	ACCREDIA <small>UNIVERSITÀ ITALIANA DI ACCREDITAMENTO</small>	Height preset 50/100 contact 1 central point	159,00
R009.648	Calib. Rep.	Height preset 50/100 contact 1 central point	68,00



R003.066	Calib. Rep.	Protractors and universal bevel protractors with 1 rod	113,00
R003.995	Calib. Rep.	Digital prot. and universal bevel protractors with 1 rod	123,00



C935.001	ACCREDIA	Roughness testers 1 area / 1 parameter	173,00
C935.002	ACCREDIA	Roughness testers 2 areas / 1 parameter per area	219,00
C935.003	ACCREDIA	Roughness testers 3 areas / 1 parameter per area	261,00
R935.001	Calib. Rep.	Roughness testers 1 area / 1 parameter	138,00
R935.002	Calib. Rep.	Roughness testers 2 areas / 1 parameter per area	179,00
R935.003	Calib. Rep.	Roughness testers 3 areas / 1 parameter per area	252,00



R906.601	Calib. Rep.	Rockwell scale hardness testers	104,00
R906.605	Calib. Rep.	Brinell scale hardness testers	104,00
R906.607	Calib. Rep.	Vickers scale hardness testers, over 1 kg	104,00
R009.600	Calib. Rep.	Shore A-D scale hardness testers	104,00



C701.714	ACCREDIA	Analog/digital dial gauges or lever touch probes	106,00
R701.714	Calib. Rep.	Analog/digital dial gauges or lever touch probes	38,00



C897.X01	ACCREDIA	Individual calibrated balls up to 100	65,00
R897.X01	Calib. Rep.	Individual calibrated balls up to 100	57,00



C724.501	ACCREDIA	Thickness gauges with analogue/digital dial gauge	106,00
R724.501	Calib. Rep.	Thickness gauges with analogue/digital dial gauge	79,00

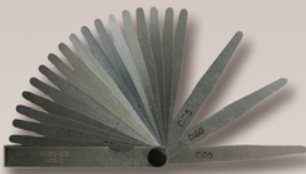

C406.108	ACCREDIA	Thickness gauge sets with 8 blades L100	99,00
C406.113	ACCREDIA	Thickness gauge sets with 13 blades L100	125,00
C406.120	ACCREDIA	Thickness gauge sets with 20 blades L100	151,00
R406.108	Calib. Rep.	Thickness gauge sets with 8 blades L100	45,00
R406.113	Calib. Rep.	Thickness gauge sets with 13 blades L100	60,00
R406.120	Calib. Rep.	Thickness gauge sets with 20 blades L100	72,00



C915.001	ACCREDIA	Individual calibrated shims	61,00
R915.001	Calib. Rep.	Individual calibrated shims	37,00



R963.X01	Calib. Rep.	Thermometers with K probes 30/1000°C on 1 point	44,00
R963.X02	Calib. Rep.	Thermometers with K probes 30/1000°C on 2 points	87,00
R963.X03	Calib. Rep.	Thermometers with K probes 30/1000°C on 3 points	131,00
R963.X00	Calib. Rep.	Each additional point to 5 points each	31,00
R963.002	Calib. Rep.	Each probe attached to the first one calibrated under the same conditions	75,00

R960.X01	Calib. Rep.	Infrared thermometers 20/300°C on 1 point	64,00
R960.X02	Calib. Rep.	Infrared thermometers 20/300°C on 2 points	131,00
R960.X03	Calib. Rep.	Infrared thermometers 20/300°C on 3 points	194,00
R960.X00	Calib. Rep.	Each additional point to 5 points each	45,00

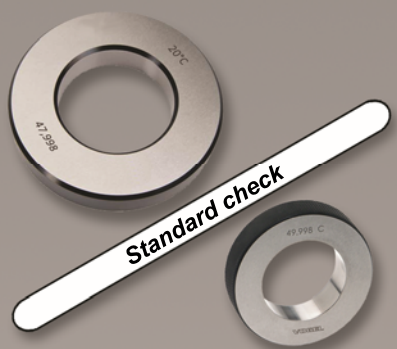

CS576.001	ACCREDIA	Smooth resetting rings $\varnothing$ 5 > 150	68,00
CS576.005	ACCREDIA	ditto min. quantity 5 pcs max. 20 pcs each	66,00
CS576.020	ACCREDIA	ditto quantity over 20 pcs	61,00

Standard check -  $\varnothing$  1 on centre line (tot. 1)

RS576.015	Calib. Rep.	Smooth resetting rings $\varnothing$ 1.5 > 20	24,00
RS576.200	Calib. Rep.	Smooth resetting rings $\varnothing$ 20 > 50	28,00
RS576.500	Calib. Rep.	Smooth resetting rings $\varnothing$ 50 > 75	35,00
RS576.750	Calib. Rep.	Smooth resetting rings $\varnothing$ 75 > 100	41,00
RS577.000	Calib. Rep.	Smooth resetting rings $\varnothing$ 100 > 150	48,00
RS577.500	Calib. Rep.	Smooth resetting rings $\varnothing$ 150 > 200	59,00



CI576.001	ACCREDIA	Smooth resetting rings $\varnothing$ 5 > 150	91,00
CI576.005	ACCREDIA	ditto min. quantity 5 pcs max. 20 pcs each	89,00
CI576.020	ACCREDIA	ditto quantity over 20 pcs	84,00

Intermediate check -  $\varnothing$  3 at 3 different heights (tot. 3)

RI576.015	Calib. Rep.	Smooth resetting rings $\varnothing$ 1.5 > 20	26,00
RI576.200	Calib. Rep.	Smooth resetting rings $\varnothing$ 20 > 50	30,00
RI576.500	Calib. Rep.	Smooth resetting rings $\varnothing$ 50 > 75	37,00
RI576.750	Calib. Rep.	Smooth resetting rings $\varnothing$ 75 > 100	43,00
RI577.000	Calib. Rep.	Smooth resetting rings $\varnothing$ 100 > 150	50,00
RI577.500	Calib. Rep.	Smooth resetting rings $\varnothing$ 150 > 200	61,00

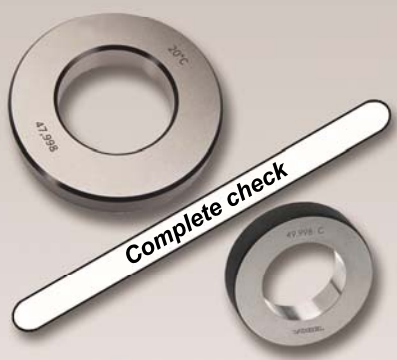

CC576.001	ACCREDIA	Smooth resetting rings $\varnothing$ 5 > 150	135,00
-----------	----------	--	--------

Complete check -  $\varnothing$  3 at 3 different heights + ovality  $\varnothing$  3 at  $90^\circ$  (tot. 6)



LAS-6001	ACCREDIA	Compulsory supplement for laser engraving	6,00
C006.001	ACCREDIA	Individual calib. plugs 1-4 pcs grade 1 or 2 each	63,00
C006.010	ACCREDIA	Set of calibrated pins 10 pcs grade 1 or 2	111,00
C006.695	ACCREDIA	Set of calibrated pins 20 pcs grade 1 or 2	179,00
C006.702	ACCREDIA	Set of calibrated plugs 100 pcs grade 1 or 2 $\varnothing$ 1-10	822,00
C006.717	ACCREDIA	Set of calibrated pins 100 pcs grade 1 or 2 $\varnothing$ 11-20	832,00

Standard check (for intermediate check +20% - full check +50%)

LAS-6001	ACCREDIA	Compulsory supplement for laser engraving	6,00
R006.001	Calib. Rep.	Individual calib. plugs 1-4 pcs grade 1 or 2 each	10,00
R006.010	Calib. Rep.	Set of calibrated pins 10 pcs grade 1 or 2	62,00
R006.695	Calib. Rep.	Set of calibrated pins 20 pcs grade 1 or 2	117,00
R006.702	Calib. Rep.	Set of calibrated plugs 100 pcs grade 1 or 2 $\varnothing$ 1-10	359,00
R006.717	Calib. Rep.	Set of calibrated pins 100 pcs grade 1 or 2 $\varnothing$ 11-20	396,00





C005.032	ACCREDIA	Set of 32 gauge blocks gr. 0-1-2 D1	249,00
C005.047	ACCREDIA	Set of 47 gauge blocks gr. 0-1-2 D1	365,00
C005.087	ACCREDIA	Set of 87 gauge blocks gr. 0-1-2 D1	681,00
C005.103	ACCREDIA	Set of 103 gauge blocks gr. 0-1-2 D1	797,00

D1 Check at 1 central point - D2 Check at 5 points incl. length variation



C555.032	ACCREDIA	Set of 32 gauge blocks gr. 0-1-2 D2	300,00
C555.047	ACCREDIA	Set of 47 gauge blocks gr. 0-1-2 D2	443,00
C555.087	ACCREDIA	Set of 87 gauge blocks gr. 0-1-2 D2	820,00
C555.103	ACCREDIA	Set of 103 gauge blocks gr. 0-1-2 D2	970,00



C500.000	ACCREDIA	Individual gauge blocks 0.5-100 1 pc gr. 0-1-2 D1	43,00
C500.003	ACCREDIA	Individual gauge blocks 0.5-100 3 pcs gr. 0-1-2 D1	106,00
C500.005	ACCREDIA	Individual gauge blocks 0.5-100 5 pcs gr. 0-1-2 D1	159,00
C500.006	ACCREDIA	Individual gauge blocks 0.5-100 6 pcs (5+1) gr. 0-1-2 D1	202,00

D1 Check at 1 central point - D2 Check at 5 points incl. length variation

C555.000	ACCREDIA	Individual gauge blocks 0.5-100 1 pc gr. 0-1-2 D2	47,00
C555.003	ACCREDIA	Individual gauge blocks 0.5-100 3 pcs gr. 0-1-2 D2	112,00
C555.005	ACCREDIA	Individual gauge blocks 0.5-100 5 pcs gr. 0-1-2 D2	173,00
C555.006	ACCREDIA	Individual gauge blocks 0.5-100 6 pcs (5+1) gr. 0-1-2 D2	219,00



C500.151	ACCREDIA	Individual gauge blocks 125-200 gr. 0-1 D1	132,00
C500.154	ACCREDIA	Individual gauge blocks 225-300 gr. 0-1 D1	140,00
C500.155	ACCREDIA	Individual gauge blocks 325-400 gr. 0-1 D1	146,00
C500.158	ACCREDIA	Individual gauge blocks 425-650 gr. 0-1 D1	154,00

D1 Check at 1 central point - D2 Check at 5 points incl. length variation

C555.151	ACCREDIA	Individual gauge blocks 125-200 gr. 0-1 D2	146,00
C555.154	ACCREDIA	Individual gauge blocks 225-300 gr. 0-1 D2	159,00
C555.155	ACCREDIA	Individual gauge blocks 325-400 gr. 0-1 D2	174,00
C555.158	ACCREDIA	Individual gauge blocks 425-650 gr. 0-1 D2	181,00



C514.008	ACCREDIA	Set of 8 gauge blocks 25-100 + 125-200 gr. 0-1 D1	679,00
C513.008	ACCREDIA	Set of 8 gauge blocks 125-500 gr. 0-1 D1	735,00

D1 Check at 1 central point - D2 Check at 5 points incl. length variation

C514.558	ACCREDIA	Set of 8 gauge blocks 25-100 + 125-200 gr. 0-1 D2	771,00
C513.558	ACCREDIA	Set of 8 gauge blocks 125-500 gr. 0-1 D2	911,00



C515.010	ACCREDIA	Set of 10 pcs gauge blocks for micrometer check 0:25- 2.5-25 gr. 1 D1	99,00
C515.011	ACCREDIA	Set of 11 pcs gauge blocks for micrometer check 0:25- 1.4-25 gr. 1 D1	108,00

D1 Check at 1 central point - D2 Check at 5 points incl. length variation

C515.510	ACCREDIA	Set of 10 pcs gauge blocks for micrometer check 0:25- 2.5-25 gr. 1 D2	113,00
C515.511	ACCREDIA	Set of 11 pcs gauge blocks for micrometer check 0:25- 1.4-25 gr. 1 D2	125,00



C516.254	DAKKS	Set of 5 pcs for dial gauge check (3 gauge blocks + 2 rings) gr. 1 D2	322,00
C516.256	DAKKS	Set of 6 pcs for dial gauge check (4 gauge blocks + 2 rings) gr. 1 D2	524,00



# 11 LEVEL<sup>®</sup>

## INSTRUMENTS



**POSSIBILITY OF  
CUSTOMISING  
ALMOST ALL  
ARTICLES THROUGH  
OUR LASER SERVICE**



**VOGEL SRL**



**VOGEL SRL**



**392 7755222**



**VOGEL SRL**



**VOGEL SRL**

**VOGEL srl**

**Via A. Vespucci, 3/5  
25024 LENO (BS)**

**VAT No.: 01594040980**

**Tel: 030 906591 r.a.  
rollover lines**

**Web: [www.vogel.it](http://www.vogel.it)**

**Mail: [info@vogel.it](mailto:info@vogel.it)**

**sponsor:**

*Team*  
**STOCCHETTI**

**This promotion was introduced by:**